

HKKChain

General Catalog

SOLID BUSHING
SOLID ROLLER
SOLID POWER

SOLID BUSHING
SOLID ROLLER
SOLID POWER

SOLID BUSHING
SOLID ROLLER
SOLID POWER

SOLID BUSHING
SOLID ROLLER
SOLID POWER

SOLID BUSHING
SOLID ROLLER
SOLID POWER

SOLID BUSHING
SOLID ROLLER
SOLID POWER

SOLID BUSHING
SOLID ROLLER
SOLID POWER

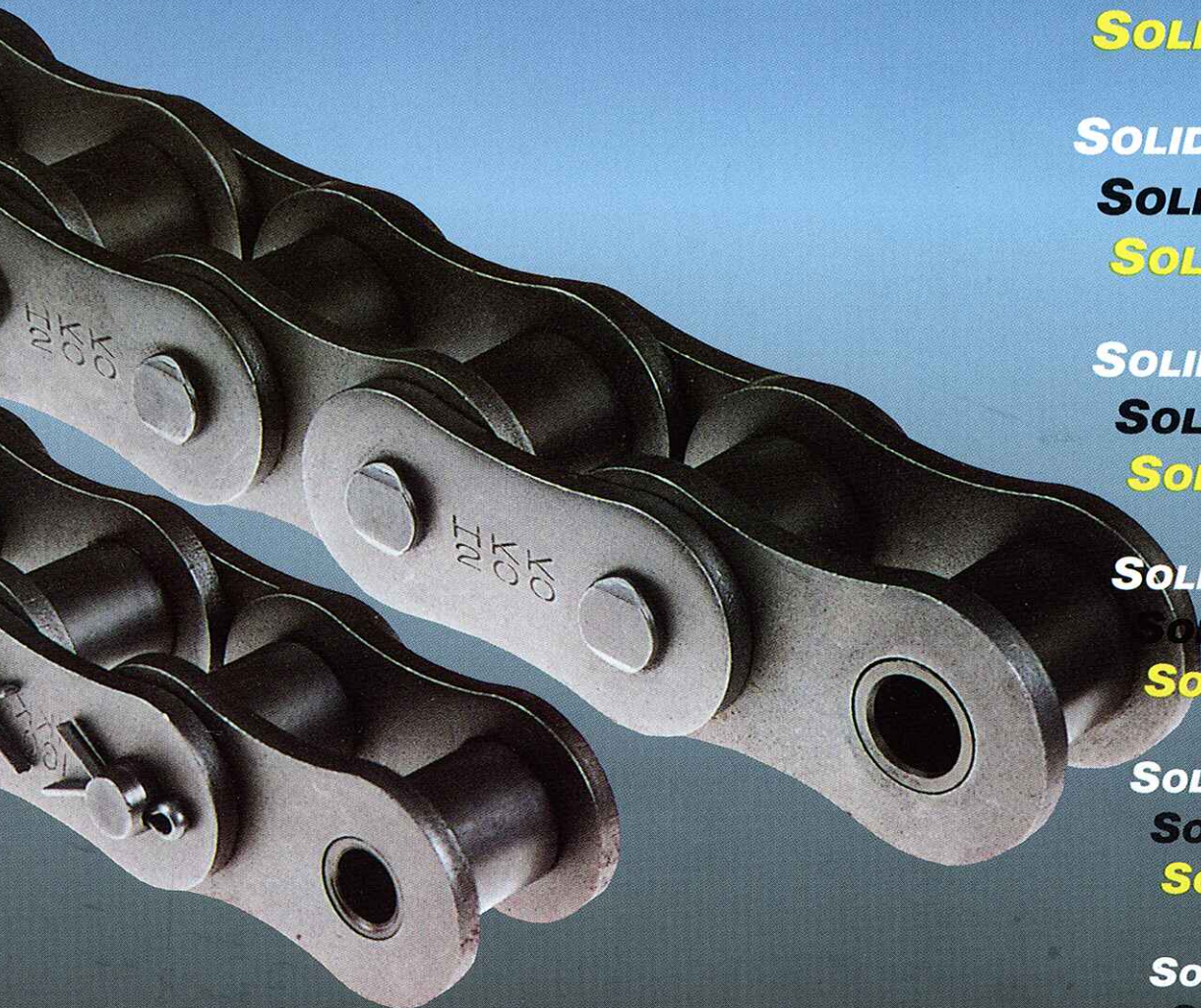

HKK CHAIN CORPORATION

Devoted to providing the highest quality products and excellence in service, while always maintaining competitive pricing.



* **HKK CHAIN CORPORATION**

• 9 Riverside Drive
∞ P.O. Box 604
Pine Brook, NJ 07058
Phone: 973-575-7860
800-631-1056
Fax: 973-575-7250

* **LARZ INDUSTRIES, INC.**

11383 Casa Lorna Drive
Brighton, MI 48114
Phone: 810-225-8474
Fax: 810-225-8460

* **BRANDON COMPANY, INC.**

• 790 West 1760 South #4
Salt Lake City, UT 84104
Phone: 801-487-2231
Fax: 801-485-1521

* **R.C. TURK COMPANY**

700 Great Southwest Pkwy
Atlanta, GA 30336
Phone: 404-344-4035
Fax: 404-344-8391

* **HKK CHAIN CORPORATION**

• 9730 S.W. Hillman Court
∞ Suite 630
Wilsonville, OR 97070
Phone: 503-682-4933
888-242-4933
Fax: 503-682-1879

* **SISCO, INC.**

• 1482 Champion Road
∞ Terrell, TX 75160
Phone: 972-563-3846
800-527-1406
Fax: 972-563-4134

* **THREE RIVERS INDUSTRIAL PRODUCTS**

8 Glennvue Drive
Pittsburgh, PA 15205
Phone: 412-788-6517
Fax: 412-788-6519

* **HKK CHAIN CORPORATION**

736 Elder Court
Glencoe, IL 60022
Phone: 847-256-7733
Fax: 847-256-7733

* **SPECIALTY PRODUCTS**

3901-D Nebraska Street
Newportville, PA 19056
Phone: 215-785-6003
Fax: 215-785-6028

* **OEM SOLUTIONS, INC.**

P.O. Box 510
Webster, NY 14580
Phone: 585-670-9178
Fax: 585-787-9903

* **N.T.S.**

6 Springfield Street
Belmont, MA 02478
Phone: 617-834-8589

* Sales Office • Warehouse Facility
∞ Available for cutting and assembling chain

Linking The World	2
History of Roller Chain	3
The HKK Solid Advantage	4
General Information	5
Standard ANSI Roller Chain	6-7
Heavy Series Roller Chain	8
Super & Super Heavy Chain	9
Double Pitch Roller Chain	10
British Standard Chain	11
Stainless Steel Chain	12
British Standard Stainless Steel Chain	12
Stainless Steel Double Pitch Chain	13
Nickel Plated Chain	14
Side Bow Chain	15
Hollow Pin Chain	15
Leaf Chain	16
Chain Tools	17
Coupling Chain	17
Attachment Chain	18
Standard Attachments	19
Single Pitch Attachments	20
Double Pitch Attachments	21
British Standard Attachments	22
Special Attachments	23
Welded Steel Mill Chain	24
81X Transfer Chains	25
81X Attachments	25
81X Roof-Top Chain	26
Sticker Chain	26
Edger Chain	27
Heavy Edger Chain	27
Maintenance Check List	28
Aqua-Series Chain	29

Since being founded in 1916, HKK Chain has concentrated its efforts on the manufacturing of roller chain. With decades of experience and continuous research in the roller chain field, HKK consistently produces chain of high quality, uniformity, and durability.

HKK roller chains are ideal for many industrial and agricultural applications. In addition to use on plant machinery and farm equipment, HKK chains are found in the lumber, mining, oil, food processing, packaging, construction, and many other industries. The basic function of HKK roller chain is the transmission of mechanical power with a high degree of efficiency. By using HKK Chain, you can eliminate power loss and down time while being sure of profitable, high level production. HKK roller chains are manufactured to meet our own tough standards, well exceeding American National Standard Institute standards. HKK chains are dimensionally interchangeable with any other chains conforming to ANSI standards.

HKK Chain is continually striving to make new breakthroughs in roller chain design. Combining quality, convenience, reliability, and cost with new technology, improved materials, and an expanded application base, HKK is ready to provide the highest quality chain worldwide well into the next century.

Here are a few features, which we invite you to compare, point by point, with other power transmission methods.

Drive Efficiency: The drive efficiency rating of HKK roller chain is over 98%. As positive as gears and as flexible as belts, HKK roller chain provides an ideal transmission of power with exact speed ratio. Throughout the entire working life, there is no power loss through friction or slippage.

Economy: HKK roller chains offer maximum operating advantages at minimum cost. They are also easily removed and maintained. These qualities, combined with precision manufacturing, provide trouble-free service.

HKK roller chains are manufactured from the highest quality steel. Chains should be recycled after use, helping to clean our environment and protect our natural resources.

Durability: HKK roller chains are comparatively light in weight, yet they embody great strength. The elasticity of HKK chains absorbs shock and vibration, thereby protecting other machine components.

Flexibility: HKK roller chains are well suited to a broad range of operating conditions, short or long shaft center distances: multiple shafts drives; slow or fast speeds; light or heavy loads; frequent starts and stops. HKK chains can be expanded, shortened, or customized using various attachments with relative ease. They are also highly resistant to adverse environmental conditions caused by temperature, dust, moisture, etc.



HKK Chain, with its cold-forged, solid bushings, solid rollers, and specially treated pins and bushings provides a unique advantage over conventional chains. HKK's cold forging method creates a mirror-like finish, allowing all kinetic surfaces to fit together precisely. The pins and bushings are then specially treated to provide less friction and higher corrosion resistance. The result is a smoother running, longer lasting chain with no initial stretch, and better corrosion resistance. Solid rollers and solid bushings are only two of HKK's advanced features.

SOLID BUSHINGS: HKK's cold-forged solid bushings retain their cylindrical inside and outside walls even after side plates are pressed on, resulting in better pin bushing contact for longer chain life (A). Conventional split bushings deform into a barrel shape when side plates are pressed on, leaving only small contact areas between pins and split bushings (B). These small contact areas build more friction and heat, that causes premature wear. Unlike split bushings, HKK solid bushings are shot peened for higher fatigue strength.

SOLID ROLLERS: HKK's cold-forged solid rollers also have extremely cylindrical walls both inside and out for better bushing-roller and roller-sprocket contact. Unlike split rollers, HKK solid rollers are shot peened for greater fatigue strength.

TREATED PINS & BUSHINGS: HKK pins and bushings are specially treated to reduce friction and corrosion in the critical bearing area of the pin and bushings. This treatment will also help increase chain life while running and prevent corrosion during shut down.

LINK PLATES: HKK link plate center heights are increased for greater fatigue strength and shock resistance (C). The holes of the link plate are double punched. This process provides true 90-degree holes for exact pin-plate, bushing-plate alignment. HKK link plates are also shot peened for greater fatigue strength.

PINS: HKK pins are specially designed for each size of chain. Exclusively selected steel and superior heat treatment provides strength and toughness for higher wear resistance and load capacity. Larger size chain pins are ground after heat treatment to ensure straightness.

LUBRICATION: HKK chains are pre-lubricated by a hot dipping process that ensures total lubrication of all component parts to prolong chain life.

HEAT TREATMENT: Proper heat treatment of all chain component parts is essential for long chain life. HKK's heat treatment process is done with a technologically advanced furnace specially designed for HKK. Consistently meeting HKK's highest standards of heat treatment, HKK chain has been trusted to be dependable, consistent, and durable.

Solid Bushing (A)

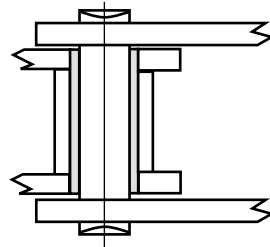

Split Bushing (B)

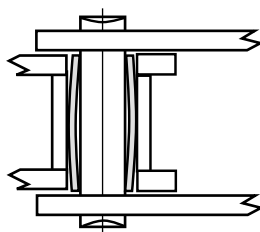

HKK (C)

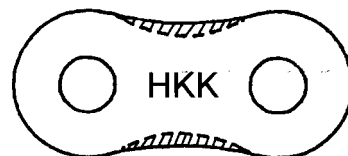

Conventional

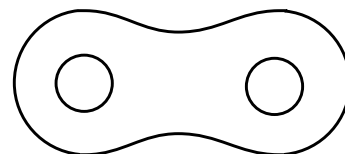

HKK Solid Bushing, Solid Roller Chain With New Treated Pin & Bushings

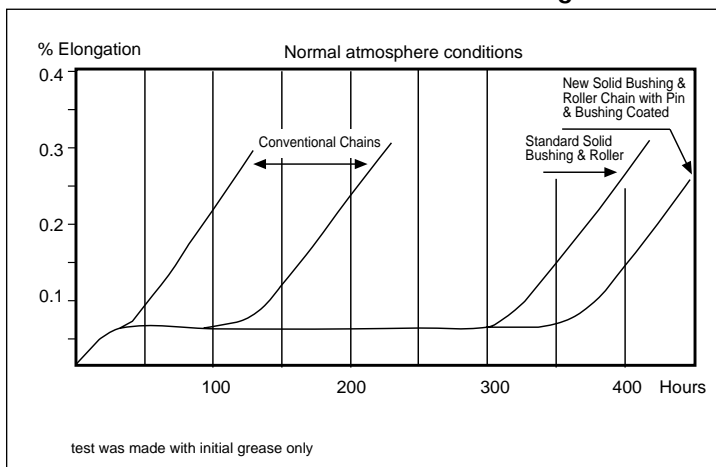

History of Roller Chain

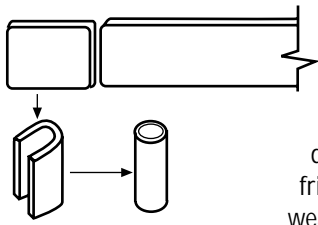

Over the past 85 years there have been very few changes in the design of roller chain. Roller chain has been constructed with side plates, pins, bushings, and rollers. Bushings and rollers have been manufactured by stamping flat steel and curling it into shape. The curled, split bushing tends to deform to a barrel shape when it is assembled with the roller link plates. This deformity results in uneven contact between the pin and bushing. This uneven contact creates friction and wear in the live-bearing area between the pin and bushing. Chain elongates and wears out quickly due to this pin-bushing wear.

Conventional Split Bushing

HKK's solid bushings and solid rollers are cold-forged from steel rod. This cold-forming process allows us to design bushings and rollers that hold a totally cylindrical inside diameter after being assembled into the side plates. The result is complete pin bushing contact, which minimizes elongation caused by friction and uneven wear.

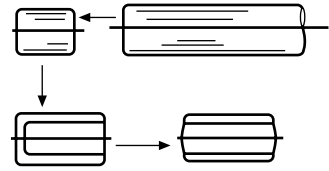

HKK Solid Bushing

To combat the effects of heavy loads, HKK assembles its roller links with cold-forged solid rollers. Manufactured with the same precision as our solid bushings, the solid rollers also contribute to extended chain life.

This revolutionary cold-forging process results in finely finished inside surfaces, while allowing outside surfaces to be shot-peened for greater fatigue strength. This shot peening process is not possible on split bushings and rollers. Cold-forging also works with the molecular structure (Grain) of the steel running lengthwise in the rollers and bushings thereby increasing fatigue resistance.

HKK cold-forged solid bushing / solid roller chain retains lubrication much longer than standard curled bushing chain. There is less lubricant burn-off because there is less friction and therefore less heat created between the pin and bushing.

In tests conducted at our factory our solid bushing solid roller chain lasted up to 3 times longer than conventional split bushing chains.

HKK offers this cold-forged solid bushing and solid roller advantage as standard on all our ANSI standard transmission and conveyor series, carbon steel and nickel-plated chains. Heavy chains, and nickel-plated chains, and most British standard metric chains also come standard with solid bushings and solid rollers.

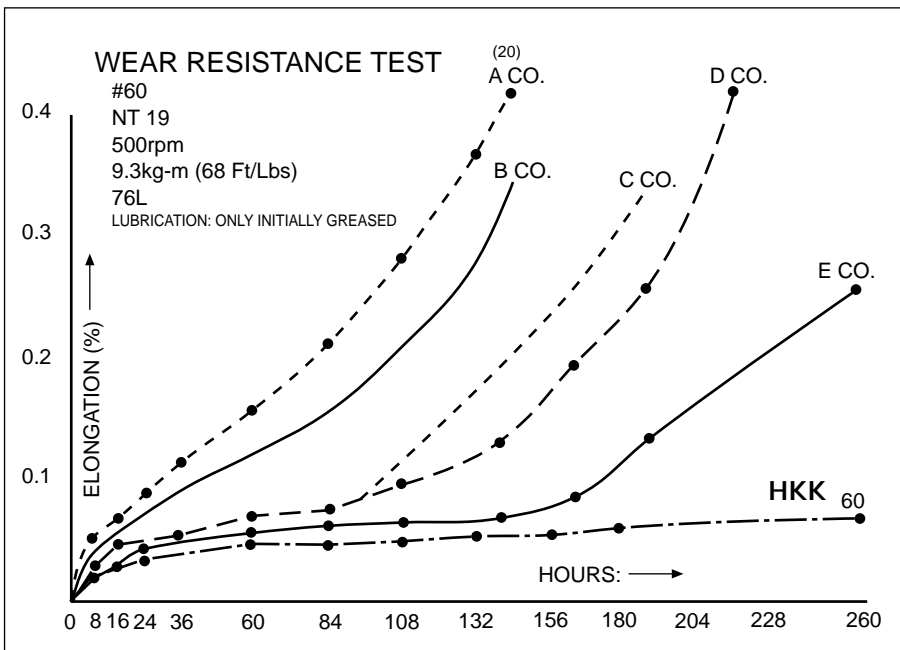

HKK stainless steel chain is manufactured with solid rollers. This unique feature minimizes roller distortion under heavy loads. Solid rollers also prevent any foreign matter from building up under the rollers, thereby avoiding rollers splitting and falling off as with conventional split rollers.

HKK's research and development department is constantly searching for new ideas to increase roller chain life. Many new products are currently being tested and supplied. Current research includes corrosion resistance and lube free chains as well as trying to obtain greater chain strength. HKK also specializes in working with new and problem applications.

STANDARD PACKAGING

HKK ANSI chains and British Standard chains are packed in 10-ft lengths with one connecting link. Chains are also available on reels, with one connecting link per 10'.

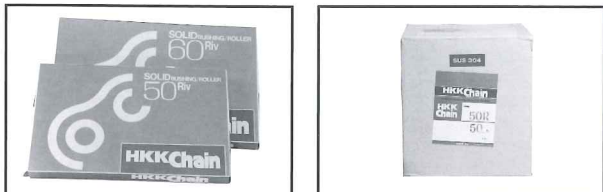

SPARE PARTS



Connecting Link
Spring Clip

CONNECTING LINK: Spring clip type is standard for small pitch chains through size #60.



Connecting Link
Cottered

CONNECTING LINK: Cotter type is standard for #80 chain through #180 chain.



Connecting Link
Single Pin Cotter

CONNECTING LINK: Single pin cotter type is standard for #200 and #240 chains.



Offset Link

OFFSET LINK: When a strand of chain consists of an odd number of pitches, an offset link is needed to assemble the chain. Assembly is simple, and chains can be custom fit to your power transmission needs. (Also known as a half link).



Pin Link

PIN LINK: (ISO Outer link): Permanent outside link that cannot be removed. Consists of a U-link and a press fit plate.



Roller Link

ROLLER LINK: (ISO Inner link)



"2-Pitch"
Offset Link

2-PITCH OFFSET LINK: Consists of an offset link and a roller link permanently riveted together. Standard for 1/4 inch pitch and smaller chains.

ANSI: American National Standard Institute
ISO: International Standard Organization

SPECIFIC LENGTHS

Chain cut to specific lengths are available for OEM requirements and for replacement chain. When ordering, specify the total number of pitches needed including the number of connecting links and/or offset links. Also, please indicate whether the chains should be shipped assembled or unassembled.

CUT TO LENGTH CHAINS

When ordering a cut length of chain, the assembly should be described as specifically as possible.

Roller chain with connecting link

Generally, an even number of pitches includes a connecting link.

Example: 40riv, 62 pitches including 1 connecting link. (61 + C/L)



Roller chain with connecting link and offset link

Generally, when an odd number of pitches is required, a connecting link and an offset link are used.

Example: 80riv, 75 pitches including 1 connecting link and 1 offset link. (73 + C/L + O/L)



Roller chain with connecting link on both ends

For odd pitch strands which are not assembled endless, 2 connecting links are available.

Example: 60riv, 79 pitches including 2 connecting links. (C/L + 77 + C/L)



Roller chain with roller link on both ends

When neither a connecting link nor an offset link is required, specify that the chain strand has a roller link on each end.

Example: 40riv, 55 pitches with roller link on each end. (55 RLEE)



Roller chain endless

It is standard to furnish chain unassembled. If an endless chain assembly is convenient for your application, indicate whether it is to be riveted endless (permanent connection), or connected endless with a connecting link (detachable).

Example: 60riv, 22 pitches riveted endless with pin link. (21 + P/L Endless) Not Shown.

**QUICK
REFERENCE
GUIDE**

- Solid Bushings ➤ Solid Rollers ➤ Specially Coated Pins & Bushings on Single Strand Sizes ➤ High Grade Alloy Steel ➤ Shot Peened Bushings, Rollers & Side Plates

HKK's precision power transmission roller chains are manufactured for high strength and long life. HKK solid bushings and rollers, specially treated pins and bushings, and stringently controlled heat treatment are only a few of the many features built into HKK chain. HKK meets or exceeds ANSI standard B29.1, making HKK the most suitable selection for almost any application. For more advantages of HKK chain see pages-3-5.

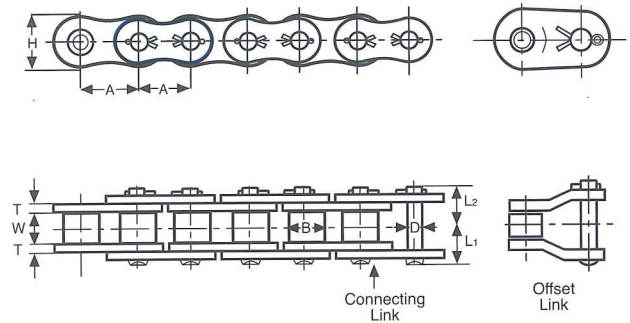

SINGLE STRAND

HKK Chain No.	Pitch A	Roller		Pin Dia. D	Plate		Overall Width		Transverse Pitch G	Maximum Allowable Load (lbs)	Average Ultimate Strength (lbs)	Average Weight Per Foot (lbs)							
		Dia. B	Width W		Height H	Thickness T	L1	L2				Riveted	Cottered						
** HKK 25	1/4	0.130	1/8	0.0905	0.236	0.030	0.150	0.185	-	140	1,050	0.09	-						
* HKK 35	3/8	0.200	3/16	0.141	0.347	0.050	0.233	0.267	0.398	560	2,400	0.23	-						
* HKK 35-2							0.432	0.454						810	4,800	0.42			
* HKK 35-3							0.630	0.666									1,210	7,200	0.62
* HKK 35-4							0.831	0.867											
** HKK 41	1/2	0.306	1/4	0.141	0.386	0.050	0.266	0.312	-	500	2,600	0.27	-						
HKK 40	1/2	0.312	5/16	0.156	0.457	0.060	0.323	0.354	0.567	940	4,300	0.40	-						
HKK 40-2							0.603	0.645		1,370	8,600	0.82	-						
HKK 40-3							0.882	0.933		2,025	12,900	1.24	-						
HKK 40-4							1.177	1.236		2,670	17,200	1.67	-						
HKK 50	5/8	0.400	3/8	0.200	0.571	0.080	0.400	0.445	0.712	1,620	7,200	0.67	-						
HKK 50-2							0.752	0.803		2,380	14,400	1.36	-						
HKK 50-3							1.099	1.169		3,500	21,600	2.02	-						
HKK 50-4							1.472	1.536		4,620	28,800	2.69	-						
HKK 60	3/4	0.469	1/2	0.234	0.689	0.094	0.500	0.548	0.898	2,470	10,000	0.98	1.02						
HKK 60-2							0.945	1.000		3,315	20,000	1.98	2.02						
HKK 60-3							1.386	1.457		4,875	30,000	2.98	3.02						
HKK 60-4							1.854	1.933		6,435	40,000	3.98	4.02						
HKK 60-5							2.299	2.378		7,740	50,000	4.98	5.02						
HKK 60-6							2.752	2.831		9,130	60,000	5.98	6.02						
HKK 60-6							3.650	3.732		12,300	80,000	7.98	8.02						
HKK 80							1	0.625		5/8	0.312	0.921	0.125	0.628	0.750	1.153	4,290	17,700	1.69
HKK 80-2	1.201	1.319	5,610	35,400	3.42	3.47													
HKK 80-3	1.780	1.898	8,250	53,100	5.16	5.20													
HKK 80-4	2.366	2.488	10,890	70,800	6.89	6.93													
HKK 80-5	2.945	3.063	12,900	88,500	8.62	8.67													
HKK 80-6	3.524	3.638	15,210	106,200	10.36	10.40													
HKK 80-6	4.677	4.791	20,500	141,600	13.82	13.87													
HKK 100	1-1/4	0.750	3/4	0.375	1.154	0.156			0.772					0.913	1.409		6,600	26,200	2.63
HKK 100-2							1.475	1.608	8,600	52,400	5.20	5.26							
HKK 100-3							2.180	2.313	12,650	78,600	7.78	7.84							
HKK 100-4							2.898	3.031	16,690	104,800	10.35	10.42							
HKK 100-5							3.598	3.740	19,780	131,000	12.93	13.00							
HKK 100-6							4.303	4.450	23,320	157,200	15.51	15.58							
HKK 100-6							5.713	5.854	31,440	209,600	20.67	20.73							

* - Rollerless Chain: Roller Diameter "B" is identical to the bushing diameter, as these chains have no rollers
 ** - Split Bushing Chains

Dimensions in inches & pounds

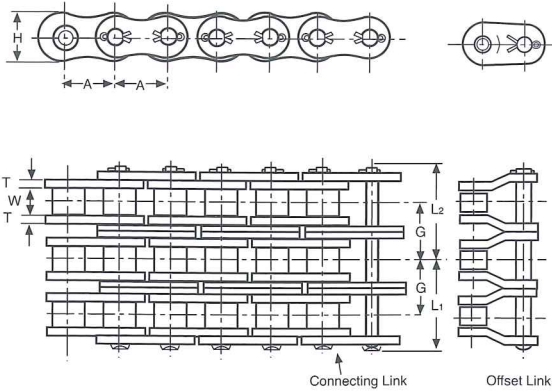

Standard Length Packaging

Chain No.	Pitch (Inches)	Standard 10' Box	20' Box	50' Reel	100' Reel	200' Reel	250' Reel	500' Reel
25	1/4	480 Links	-	-	-	-	-	X
35	3/8	320 Links	X	X	X	-	X	-
40	1/2	240 Links	X	X	X	X	-	-
41	1/2	240 Links	-	-	-	-	X	-
50	5/8	192 Links	X	X	X	-	-	-
60	3/4	160 Links	X	X	X	-	-	-
80	1	120 Links	-	X	-	-	-	-
100	1-1/4	96 Links	-	X	-	-	-	-
120	1-1/2	80 Links	-	-	-	-	-	-
140	1-3/4	68 Links	-	-	-	-	-	-
160	2	60 Links	-	-	-	-	-	-
180	2-1/4	54 Links	-	-	-	-	-	-
200	2-1/2	48 Links	-	-	-	-	-	-
240	3	40 Links	-	-	-	-	-	-

MULTIPLE STRAND

HKK Chain No.	Pitch A	Roller		Pin Dia. D	Plate		Overall Width		Transverse Pitch G	Maximum Allowable Load (lbs)	Average Ultimate Strength (lbs)	Average Weight Per Foot (lbs)	
		Dia. B	Width W		Height H	Thickness T	L1	L2				Riveted / Cottered	
												Riveted	Cottered
HKK 120	1-1/2	0.875	1	0.437	1.382	0.187	0.971	1.124	1.787	8,870	37,700	3.87	3.91
HKK 120-2							1.857	2.010		11,560	75,400	7.71	7.78
HKK 120-3							2.749	2.901		17,000	113,100	11.56	11.62
HKK 120-4							3.661	3.815		22,440	150,800	15.40	15.49
HKK 120-5							4.555	4.705		26,650	188,500	19.24	19.33
HKK 120-6							5.449	5.598		31,440	226,200	23.09	23.18
HKK 120-8	7.228	7.394	42,370	301,600	30.78	30.87							
HKK 140	1-3/4	1.000	1	0.500	1.610	0.219	1.060	1.228	1.927	11,740	48,800	4.98	5.02
HKK 140-2							2.008	2.185		15,300	97,600	9.82	9.87
HKK 140-3							2.983	3.163		22,500	146,400	14.71	14.78
HKK 140-4							3.957	4.126		29,700	195,200	19.60	19.67
HKK 140-5							4.921	5.087		35,250	244,000	24.49	24.58
HKK 140-6							5.882	6.051		41,580	292,800	29.38	29.47
HKK 140-8	7.800	7.980	56,040	390,400	39.16	39.20							
HKK 160	2	1.125	1-1/4	0.562	1.839	0.250	1.262	1.435	2.303	15,490	62,200	6.58	6.71
HKK 160-2							2.414	2.586		20,230	124,400	13.07	13.20
HKK 160-3							3.556	3.728		29,750	186,600	19.56	19.69
HKK 160-4							4.728	4.902		39,270	248,800	26.04	26.18
HKK 160-5							5.878	6.078		46,430	311,000	32.53	32.67
HKK 160-6							7.031	7.200		54,760	373,200	39.02	39.16
HKK 160-8	9.331	9.520	73,810	497,600	52.00	54.13							
HKK 180	2-1/4	1.406	1-13/32	0.687	2.067	0.283	1.429	1.658	2.587	17,730	77,700	9.00	9.31
HKK 180-2							2.720	2.950		22,100	155,400	17.89	18.09
HKK 180-3							4.027	4.249		32,500	233,100	26.78	26.98
HKK 180-4							5.315	5.539		42,900	310,800	35.67	35.89
HKK 180-5							6.610	6.827		53,310	388,500	44.56	44.78
HKK 180-6							7.902	8.118		62,870	466,200	53.44	53.67
HKK 200	2-1/2	1.562	1-1/2	0.781	2.354	0.312	1.542	1.876	2.819	20,870	102,000	11.38	11.53
HKK 200-2							2.953	3.288		27,200	204,000	22.67	22.82
HKK 200-3							4.361	4.667		40,000	306,000	33.96	34.11
HKK 200-4							5.772	6.130		52,800	408,000	45.24	45.41
HKK 200-5							7.189	7.527		62,760	510,000	56.53	56.69
HKK 200-6							8.598	8.933		74,030	612,000	67.82	68.00
HKK 240	3	1.875	1-7/8	0.936	2.768	0.375	1.900	3.457	3.457	28,950	148,000	15.89	16.11
HKK 240-2							3.626	3.925		37,400	296,000	31.67	31.89
HKK 240-3							5.354	5.654		55,000	444,000	47.44	47.67
HKK 240-4							7.079	7.378		73,480	592,000	63.22	63.49

Dimensions in inches & pounds

**QUICK
REFERENCE
GUIDE**

- Solid Bushings ➤ Solid Rollers ➤ Through Hardened Pins
- High Grade Alloy Steel ➤ Single Strand Runs On Standard Sprockets

HKK Heavy series roller chains have increased link plate thickness to provide greater capacity without fatigue failure. Link plate thickness is that of the next larger size chain. The letter "H" following the number signifies the chain is of the Heavy series. Unlike many other brands, HKK single strand Heavy chains are manufactured with solid bushings, solid rollers, and through-hardened pins. Multiple strand Heavy series chains are also available.

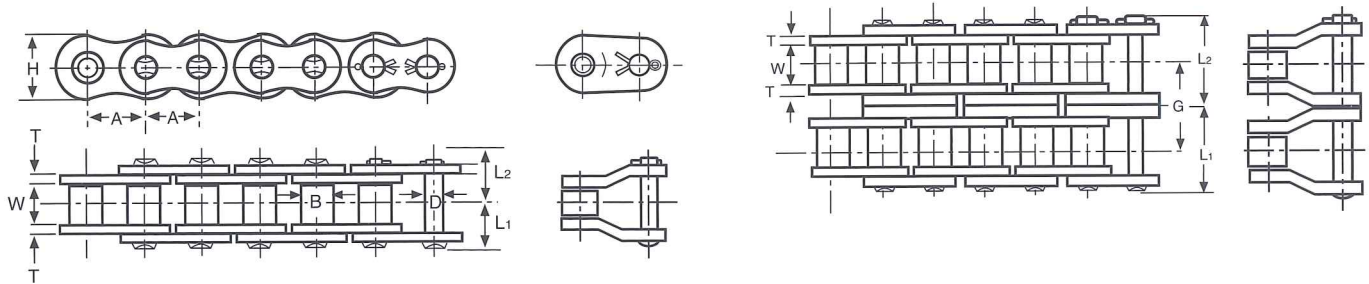

HKK Heavy Chain No.	Pitch A	Roller		Pin	Plate		Overall Width		Transverse Pitch G	Maximum Allowable Load (lbs)	Average Ultimate Strength (lbs)	Average Weight Per Foot (lbs)	
		Dia. B	Width W	Dia. D	Height H	Thickness T	L1	L2				Riveted	Coilerted
HKK 35H* HKK 40H*	3/8 1/2	0.200 0.312	3/16 5/16	0.141 0.156	0.354 0.457	0.060 0.080	0.256 0.366	0.295 0.414	- -	670 1,030	2,850 4,300	0.28 0.55	- -
HKK 50H HKK 50-2H	5/8	0.400	3/8	0.200	0.571	0.094	0.433 0.819	0.496 0.882	0.772	1,620 2,400	8,150 16,300	0.84 1.58	- -
HKK 60H HKK 60-2H	3/4	0.469	1/2	0.234	0.689	0.125	0.565 1.077	0.644 1.606	1.028	2,000 3,400	12,300 24,600	1.21 2.41	- -
HKK 80H HKK 80-2H	1	0.625	5/8	0.312	0.921	0.156	0.699 1.346	0.817 1.461	1.283	3,400 5,800	20,200 40,400	1.89 3.72	1.96 3.87
HKK 100H HKK 100-2H	1-1/4	0.750	3/4	0.375	1.154	0.187	0.831 1.606	0.969 1.740	1.539	5,200 8,800	30,800 61,600	2.78 5.51	2.83 5.62
HKK 120H HKK 120-2H	1-1/2	0.875	1	0.437	1.382	0.219	1.036 2.010	1.208 2.167	1.925	7,000 12,000	41,800 83,600	3.92 7.77	4.00 7.93
HKK 140H HKK 140-2H	1-3/4	1.000	1	0.500	1.610	0.250	1.122 2.155	1.304 2.337	2.055	9,200 15,700	54,200 108,400	5.65 11.15	5.76 11.37
HKK 160H HKK 160-2H	2	1.125	1-1/4	0.562	1.839	0.281	1.333 2.555	1.534 2.760	2.437	12,300 20,900	68,700 137,400	7.30 14.25	7.52 14.67
HKK 180H HKK 180-2H	2-1/4	1.406	1-13/32	0.687	2.067	0.312	1.490 2.844	1.723 3.071	2.700	13,400 22,800	83,700 167,400	10.20 20.20	10.50 20.60
HKK 200H HKK 200-2H	2-1/2	1.562	1-1/2	0.781	2.354	0.375	1.666 3.212	2.004 3.552	3.083	17,700 28,400	117,000 234,000	12.00 23.65	12.36 24.12

* Case Hardened Pin

Dimensions in inches & pounds

**QUICK
REFERENCE
GUIDE**

- Solid Bushings ➤ Solid Rollers ➤ Specially Selected Alloy Steel Pins
- Four Point Rivets ➤ Offset Links Not Available

HKK Super & Super Heavy series chains are designed to provide longer chain life under severe loads. Enhanced plate configuration and ball milling plate holes ensure greater tensile strength and resistance to fatigue failure. High-grade alloy steel and four point riveting provide higher shock load capacities. Super Heavy series chains have side plate thickness of the next larger chain size. Both Super and Super Heavy run on standard sprockets.

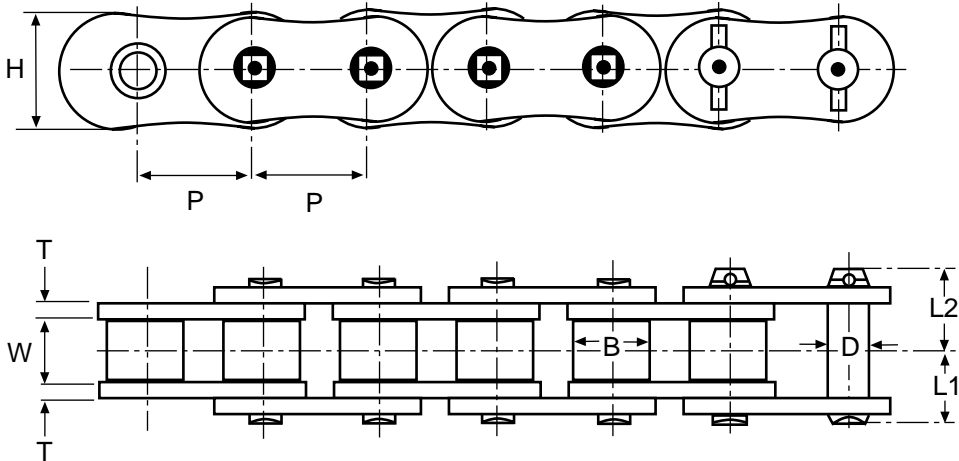

HKK Super Chain No.	Pitch A	Roller		Pin	Plate		Overall Width		Maximum Allowable Load (lbs)	Average Ultimate Strength (lbs)	Average Weight Per Foot (lbs)	
		Dia. B	Width W	Dia. D	Height H	Thickness T	L1	L2			Riveted	Cottered
HKK SUPER CHAIN												
HKK 80 Super	1	0.625	5/8	0.312	0.949	0.125	0.640	0.760	4,180	18,900	1.89	1.92
HKK 100 Super	1-1/4	0.750	3/4	0.375	1.185	0.156	0.792	0.902	6,830	28,600	2.87	2.93
HKK 120 Super	1-1/2	0.875	1	0.437	1.425	0.187	0.993	1.138	8,810	41,800	4.24	4.32
HKK 140 Super	1-3/4	1.000	1	0.500	1.661	0.219	1.075	1.249	12,100	55,100	5.41	5.52
HKK 160 Super	2	1.125	1-1/4	0.562	1.898	0.250	1.278	1.453	15,800	70,500	7.26	8.43
HKK 200 Super	2-1/2	1.562	1-1/2	0.781	2.374	0.312	1.562	1.764	21,100	110,200	11.83	12.07
HKK 240 Super	3	1.875	1-7/8	0.936	2.850	0.375	1.898	2.186	29,700	163,100	17.21	17.55
HKK SUPER HEAVY CHAIN												
HKK 80 Super H	1	0.625	5/8	0.312	0.949	0.156	0.699	0.831	4,630	22,000	2.22	2.22
HKK 100 Super H	1-1/4	0.750	3/4	0.375	1.185	0.187	0.857	0.985	7,280	32,600	3.28	3.28
HKK 120 Super H	1-1/2	0.875	1	0.437	1.425	0.219	1.058	1.221	9,480	44,000	4.67	4.67
HKK 140 Super H	1-3/4	1.000	1	0.500	1.661	0.250	1.140	1.312	12,800	57,300	5.97	5.97
HKK 160 Super H	2	1.125	1-1/4	0.562	1.898	0.281	1.347	1.540	16,500	72,700	7.87	7.87

**QUICK
REFERENCE
GUIDE**

- Solid Bushings ➤ Solid Rollers ➤ High Grade Alloy Steel
- Delrin Rollers Available ➤ Attachments Available

HKK Double-Pitch roller chain is similar to HKK standard roller chain, except the pitch is twice that of standard roller chain. These chains weigh less and are lower in cost than standard roller chain of the same strength. They are ideal for slow and moderate speed applications, particularly when shaft centers are relatively long.

There are two types of double-pitch chains. Transmission type has figure-eight shaped link plates. Conveyor type has straight edged link plates. Conveyor type chains are available with standard rollers or with oversized carrier rollers. Conveyor series chains with 1.5" pitch and larger are constructed with heavy series side plates. HKK Double-Pitch chains are manufactured to the highest standards, and with solid bushings and solid rollers.

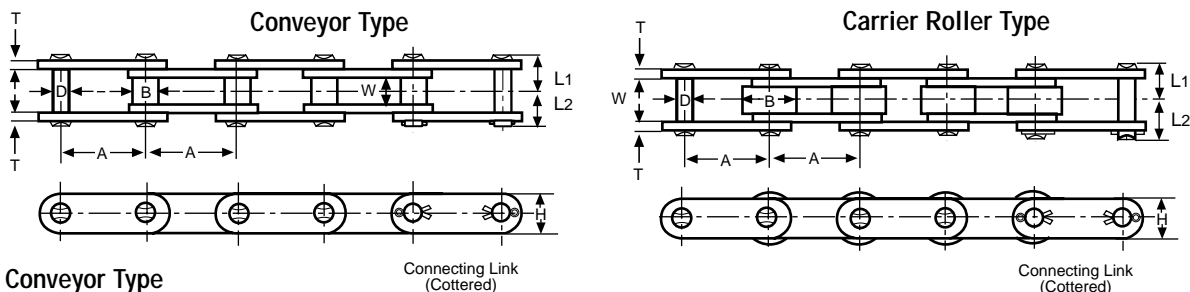

Conveyor Type

Connecting Link (Cottered)

Connecting Link (Cottered)

HKK Chain No.	Pitch	Roller		Pin Dia.	Plate		Overall Width		Maximum Allowable Load (lbs)	Average Ultimate Strength (lbs)	Average Weight Per Foot (lbs)	
		Dia.	Width		Height	Thickness	L1	L2			Riveted	Cottered
	A	B	W	D	H	T	L1	L2				
STANDARD ROLLER TYPE												
HKK C 2040	1	0.312	5/16	0.156	0.450	0.060	0.323	0.378	600	4,300	0.32	-
HKK C 2050	1-1/4	0.400	3/8	0.200	0.591	0.080	0.400	0.467	1,000	7,200	0.55	-
HKK C 2060H	1-1/2	0.469	1/2	0.234	0.670	0.125	0.565	0.657	1,400	10,000	0.93	-
HKK C 2080H	2	0.625	5/8	0.312	0.890	0.156	0.699	0.829	2,400	18,000	1.56	1.57
HKK C 2100H	2-1/2	0.750	3/4	0.375	1.126	0.187	0.831	0.969	3,900	26,200	2.33	2.35
HKK C 2120H	3	0.875	1	0.437	1.374	0.218	1.036	1.208	5,400	37,800	3.37	3.39
HKK C 2160H	4	1.125	1-1/4	0.562	1.874	0.281	1.333	1.537	9,200	62,200	5.34	5.36
CARRIER ROLLER TYPE												
HKK C 2042	1	0.625	5/16	0.156	0.450	0.060	0.323	0.378	600	4,300	0.55	-
HKK C 2052	1-1/4	0.750	3/8	0.200	0.591	0.080	0.400	0.467	1,000	7,200	0.85	-
HKK C 2062H	1-1/2	0.875	1/2	0.234	0.670	0.125	0.565	0.657	1,400	10,000	1.40	-
HKK C 2082H	2	1.125	5/8	0.312	0.890	0.156	0.699	0.829	2,400	18,000	2.27	2.29
HKK C 2102H	2-1/2	1.562	3/4	0.375	1.126	0.187	0.831	0.969	3,900	26,200	3.78	3.80
HKK C 2122H	3	1.750	1	0.437	1.374	0.218	1.036	1.208	5,400	37,800	5.34	5.36
HKK C 2162H	4	2.250	1-1/4	0.562	1.874	0.281	1.333	1.537	9,200	62,200	8.46	8.48

Dimensions in inches & pounds

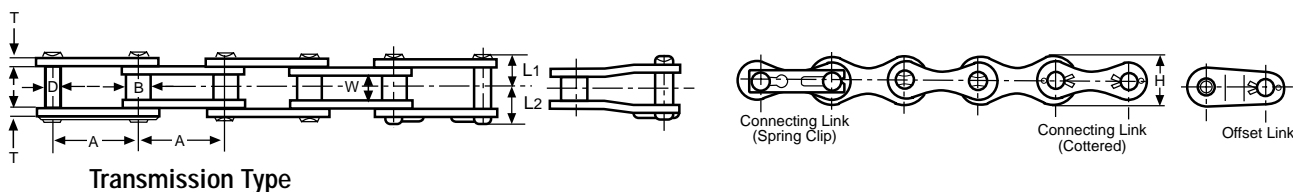

Transmission Type

HKK Chain No.	Pitch	Roller		Pin Dia.	Plate		Overall Width		Average Ultimate Strength (lbs)	Avg. Weight Per Foot (lbs)
		Dia.	Width		Height	Thickness	L1	L2		Riveted
	A	B	W	D	H	T	L1	L2		
HKK A 2040	1	0.312	5/16	0.156	0.450	0.060	0.323	0.378	4,300	0.29
HKK A 2050	1-1/4	0.400	3/8	0.200	0.571	0.080	0.400	0.407	7,200	0.49
HKK A 2060	1-1/2	0.469	1/2	0.234	0.670	0.094	0.500	0.583	9,600	0.69
HKK A 2080	2	0.625	5/8	0.312	0.890	0.125	0.628	0.750	16,800	1.15

Dimensions in inches & pounds

**QUICK
REFERENCE
GUIDE**

- Solid Bushings ➤ Solid Rollers ➤ High Grade Alloy Steel
- ISO R606 Standard ➤ 10' Lengths Standard
- Stainless Steel See Page 12 ➤ Attachments Available

HKK British Standard chain is manufactured to the same high quality specifications as our ANSI chain. Solid bushings and solid rollers dramatically increase chain life. Manufactured in accordance with ISO R606, HKK British standard chains are compatible with British standard B.S. 228 and German standard DIN 8187. Chains are supplied in 10-foot lengths. Attachment chains and stainless steel chains are available.

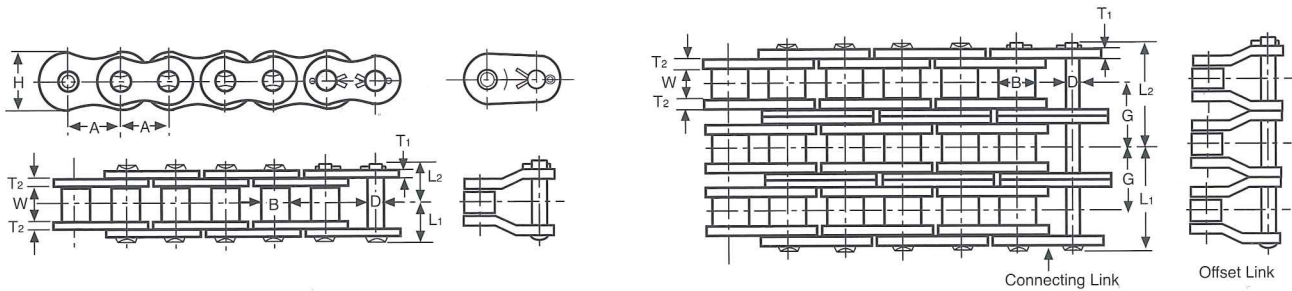

HKK British Chain No.	Pitch A	Roller		Pin Dia. D	Plate			Overall Width		Transverse Pitch G	Maximum Allowable Load	Average Ultimate Strength (lbs)	Avg. Weight Per Foot (lbs) Riveted
		Dia. B	Width W		Height H	P/L Thickness T1	R/L Thickness T2	L1	L2				
		B	W	H	T1	T2	L1	L2	G				
** HKK 04B	0.236	0.157	0.110	0.073	0.197	0.024	0.024	0.163	0.128	—	130	770	0.06
** HKK 05B	0.315	0.197	0.118	0.091	0.280	0.030	0.030	0.185	0.150	—	275	1,100	0.12
HKK 06B	3/8	0.250	0.225	0.129	0.457	0.039	0.049	0.240	0.276	0.403	380	2,300	0.29
HKK 06B-2								0.449	0.480		650	4,100	0.55
HKK 06B-3								0.650	0.677		940	5,950	0.84
HKK 08B	1/2	0.335	0.305	0.175	0.457	0.060	0.060	0.329	0.363	0.548	700	4,300	0.41
HKK 08B-2								0.602	0.638		1,200	7,700	0.85
HKK 08B-3								0.878	0.909		1,760	11,200	1.26
HKK 10B	5/8	0.400	0.380	0.200	0.571	0.065	0.065	0.374	0.422	0.653	1,100	6,000	0.60
HKK 10B-2								0.700	0.752		1,870	11,400	1.20
HKK 10B-3								1.030	1.091		2,735	17,100	1.79
HKK 12B	3/4	0.475	0.460	0.225	0.626	0.070	0.070	0.414	0.491	0.766	1,585	7,200	0.77
HKK 12B-2								0.819	0.878		2,690	13,700	1.53
HKK 12B-3								1.201	1.256		3,950	20,500	2.26
HKK 16B	1	0.625	0.670	0.325	0.792	0.122	0.154	0.691	0.805	1.255	3,680	17,500	1.74
HKK 16B-2								1.323	1.437		4,800	33,200	2.45
HKK 16B-3								1.957	2.071		7,065	49,800	5.16
HKK 20B	1-1/4	0.750	0.770	0.400	1.024	0.138	0.178	0.791	0.922	1.435	5,730	24,400	2.53
HKK 20B-2								1.512	1.657		7,470	46,300	4.88
HKK 20B-3								2.232	2.390		10,995	69,500	7.30
HKK 24B	1-1/2	1.000	1.000	0.576	1.315	0.193	0.233	1.050	1.222	1.904	8,020	41,100	4.90
HKK 24B-2								2.004	2.189		10,500	77,900	9.76
HKK 24B-3								2.957	3.142		15,435	116,800	14.62
HKK 28B	1-3/4	1.100	1.220	0.625	1.440	0.250	0.291	1.282	1.525	2.345	9,990	54,000	6.22
HKK 28B-2								2.457	2.772		13,080	102,600	12.40
HKK 28B-3								3.630	3.953		19,250	153,900	18.58
HKK 32B	2	1.150	1.220	0.701	1.642	0.250	0.272	1.284	1.550	2.305	11,450	62,500	6.68
HKK 32B-2								2.441	2.776		14,945	118,700	13.28
HKK 32B-3								3.594	3.941		21,990	178,100	19.90

** Split Bushing Chains

Dimensions in inches & pounds

**QUICK
REFERENCE
GUIDE**

- Solid Roller ➤ 300 Series Stainless Steel ➤ High Corrosion Resistance
- Recommended for -40°F to 800°F ➤ Attachments Available

HKK Stainless Steel roller chains are used in highly corrosive and extreme temperature environments. All component parts of HKK Stainless Steel roller chains are made of 300 series stainless steel, to achieve the utmost corrosion and temperature resistance.

HKK Stainless Steel chains are equipped with solid rollers. This unique solid roller will not split or deform like conventional split rollers. These solid rollers enhance durability of the chain, especially under extreme loads and temperatures. HKK Stainless Steel roller chains are manufactured in accordance with ANSI dimensional specifications. 600 series stainless steel is also available.

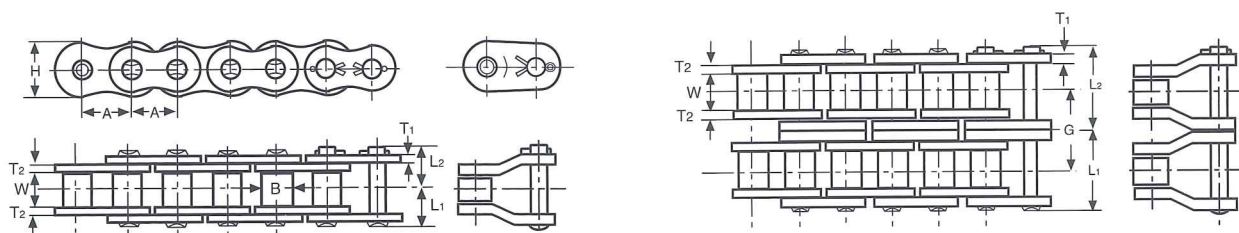

HKK Chain No.	Pitch A	Roller		Pin Dia. D	Plate		Overall Width		Transverse Pitch G	Maximum Allowable Load (lbs)	Average Ultimate Strength (lbs)	Avg. Weight Per Foot (lbs) Riveted
		Dia. B	Width W		Height H	Thickness T	L1	L2				
* HKK 25-SS	1/4	0.130	1/8	0.0905	0.236	0.030	0.150	0.185	-	22	880	0.09
* HKK 35-SS	3/8	0.200	3/16	0.141	0.347	0.050	0.233	0.267	-	60	1,440	0.23
** HKK 41-SS	1/2	0.306	1/4	0.141	0.386	0.050	0.266	0.312	-	76	1,900	0.27
HKK 40-SS	1/2	0.312	5/16	0.156	0.457	0.060	0.323	0.354	0.567	99	2,800	0.40
HKK 40-2-SS							0.603	0.645				
HKK 50-SS	5/8	0.400	3/8	0.200	0.571	0.080	0.400	0.446	0.712	154	4,450	0.67
HKK 50-2-SS							0.752	0.803				
HKK 60-SS	3/4	0.469	1/2	0.234	0.689	0.094	0.500	0.548	0.898	231	6,200	0.98
HKK 60-2-SS							0.945	1.000				
HKK 80-SS	1	0.625	5/8	0.312	0.921	0.125	0.628	0.750	1.153	396	10,670	1.69
HKK 80-2-SS							1.201	1.319				
HKK 100-SS	1-1/4	0.750	3/4	0.375	1.154	0.156	0.722	0.913	1.409	583	12,900	2.63
HKK 100-2-SS							1.475	1.608				
HKK 120-SS	1-1/2	0.875	1	0.437	1.382	0.187	0.971	1.124	1.787	869	17,300	3.87
HKK 120-2-SS							1.857	2.010				

* - Rollerless Chain: Roller Diameter "B" is identical to the bushing diameter, as these chains have no rollers & split bushings
 ** - Split Roller Chains

Dimensions in inches & pounds

British Standard Stainless Steel

HKK British Chain No.	Pitch A	Roller		Pin Dia. D	Height H	Plate		Overall Width		Maximum Allowable Load	Average Ultimate Strength (lbs)	Avg. Weight Per Foot (lbs) Riveted
		Dia. B	Width W			P/L Thickness T1	R/L Thickness T2	L1	L2			
** HKK 05B-SS	.315	0.197	0.118	0.091	0.280	0.030	0.030	0.150	0.185	26	900	0.11
** HKK 06B-SS	3/8	0.250	0.225	0.129	0.323	0.039	0.049	0.240	0.276	60	1,450	0.29
HKK 08B-SS	1/2	0.335	0.305	0.175	0.457	0.060	0.060	0.329	0.363	110	2,580	0.41
HKK 10B-SS	5/8	0.400	0.380	0.200	0.571	0.065	0.065	0.374	0.422	150	3,670	0.60
HKK 12B-SS	3/4	0.475	0.460	0.225	0.626	0.070	0.070	0.414	0.491	200	4,100	0.77
HKK 16B-SS	1	0.625	0.670	0.325	0.792	0.122	0.154	0.691	0.805	460	10,670	1.74

** - Split Roller Chains

Dimensions in inches & pounds

QUICK REFERENCE GUIDE

- Solid Roller ➤ 300 Series Stainless Steel ➤ High Corrosion Resistance
- Recommended for -40°F to 800°F ➤ Attachments Available

HKK Double-Pitch, Stainless Steel chain combine the same corrosion resistance and high temperature range as our single-pitch stainless chain, while maintaining lower cost and weight. All component parts of HKK stainless steel chains are made of 300 series stainless steel.

HKK Stainless Steel Double-Pitch chains are assembled with solid rollers. This unique solid roller will not split or deform like conventional split rollers. Solid rollers will retain their original cylindrical shape under severe loads and adverse temperatures.

Transmission type chains with figure-eight side plates are available. HKK Double-Pitch Stainless Steel chain sizes C2060H and up are manufactured with heavy side plates. Carrier rollers and attachments are also available. 600 series stainless steel is available upon request.

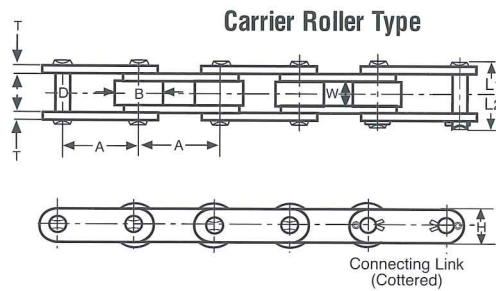
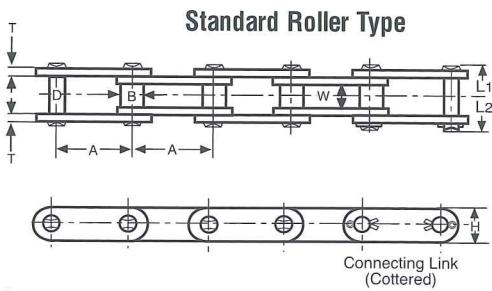

Conveyor Type

HKK Stainless Chain No.	Pitch A	Roller		Pin Dia. D	Plate		Overall Width		Maximum Allowable Load (lbs)	Average Ultimate Strength (lbs)	Avg. Weight Per Foot (lbs) Riveted
		Dia. B	Width W		Height H	Thickness T	L1	L2			
STANDARD ROLLER TYPE											
HKK C 2040-SS	1	0.312	5/16	0.156	0.450	0.060	0.323	0.378	99	2,800	0.32
HKK C 2050-SS	1-1/4	0.400	3/8	0.200	0.591	0.080	0.400	0.467	154	4,450	0.55
HKK C 2060H-SS	1-1/2	0.469	1/2	0.234	0.670	0.125	0.565	0.657	231	6,200	0.93
HKK C 2080H-SS	2	0.625	5/8	0.312	0.890	0.156	0.699	0.829	396	10,670	1.56
HKK C 2100H-SS	2-1/2	0.750	3/4	0.375	1.126	0.187	0.831	0.969	583	12,900	2.33
CARRIER ROLLER TYPE											
HKK C 2042-SS	1	0.625	5/16	0.156	0.450	0.060	0.323	0.378	99	2,800	0.55
HKK C 2052-SS	1-1/4	0.750	3/8	0.200	0.591	0.080	0.400	0.467	154	4,450	0.85
HKK C 2062H-SS	1-1/2	0.875	1/2	0.234	0.670	0.125	0.565	0.657	231	6,200	1.40
HKK C 2082H-SS	2	1.125	5/8	0.312	0.890	0.156	0.699	0.829	396	10,670	2.26
HKK C 2102H-SS	2-1/2	1.562	3/4	0.375	1.126	0.187	0.831	0.969	583	12,900	3.80

Dimensions in inches & pounds

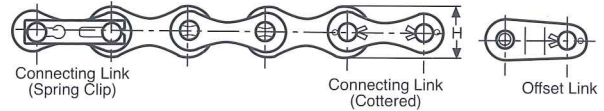
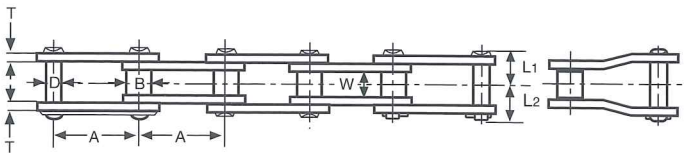

Transmission Type

HKK Stainless Chain No.	Pitch A	Roller		Pin Dia. D	Plate		Overall Width		Maximum Allowable Load	Average Ultimate Strength (lbs)	Avg. Weight Per Foot (lbs) Riveted
		Dia. B	Width W		Height H	Thickness T	L1	L2			
HKK A 2040-SS	1	0.312	5/16	0.156	0.450	0.060	0.323	0.378	99	2800	0.29
HKK A 2050-SS	1-1/4	0.400	3/8	0.200	0.591	0.080	0.400	0.467	154	4450	0.49
HKK A 2060-SS	1-1/2	0.469	1/2	0.234	0.670	0.094	0.500	0.583	231	6200	0.69
HKK A 2080-SS	2	0.625	5/8	0.312	0.890	0.125	0.628	0.750	396	10,670	1.15

Dimensions in inches & pounds

**QUICK
REFERENCE
GUIDE**

- Solid Bushing ➤ Solid Roller ➤ High Grade Alloy Steel
- Plated Before Assembly

HKK Nickel-Plated chains are used in mildly corrosive environments such as outdoors. Carbon steel Nickel-Plated chain is plated before assembly to ensure complete protection of all parts, while providing maximum strength. HKK Nickel-Plated chains are manufactured with solid rollers and solid bushings to extend chain life. Nickel-Plated attachment chains are also available. Zinc Plated chains are also available upon request.

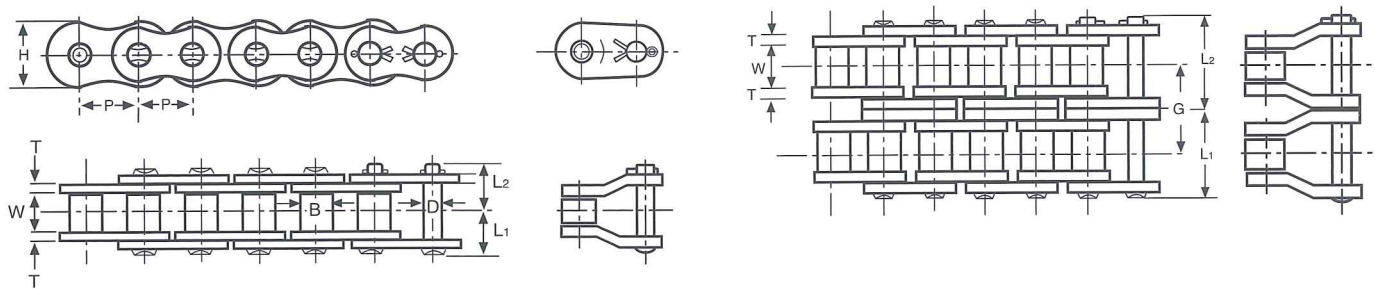

HKK Nickel Plated Chain No.	Pitch A	Roller		Pin Dia. D	Plate		Overall Width		Transverse Pitch G	Maximum Allowable Load (lbs)	Average Ultimate Strength (lbs)	Avg. Weight Per Foot (lbs) Riveted
		Dia. B	Width W		Height H	Thickness T	L1	L2				
* HKK 25-NP	1/4	0.130	1/8	0.0905	0.236	0.030	0.150	0.185	-	140	1,050	0.09
* HKK 35-NP	3/8	0.200	5/16	0.141	0.347	0.050	0.233	0.267	-	480	2,400	0.23
** HKK 41-NP	1/2	0.306	1/4	0.141	0.386	0.050	0.266	0.312	-	500	2,600	0.27
HKK 40-NP	1/2	0.312	3/16	0.156	0.457	0.060	0.323	0.354	0.567	810	4,300	0.40
HKK 40-2-NP							0.603	0.645				
HKK 50-NP	5/8	0.400	3/8	0.200	0.571	0.080	0.400	0.445	0.712	1,400	7,200	0.67
HKK 50-2-NP							0.752	0.803				
HKK 60-NP	3/4	0.469	1/2	0.234	0.689	0.094	0.500	0.548	0.898	1,950	99,000	0.98
HKK 60-2-NP							0.945	1.000				
HKK 80-NP	1	0.625	5/8	0.312	0.921	0.125	0.628	0.750	1.153	3,300	17,600	1.69
HKK 80-2-NP							1.201	1.319				

* - Rollerless Chain: Roller Diameter "B" is identical to the bushing diameter, as these chains have no rollers
 ** - Split Bushing Chains

Dimensions in inches & pounds

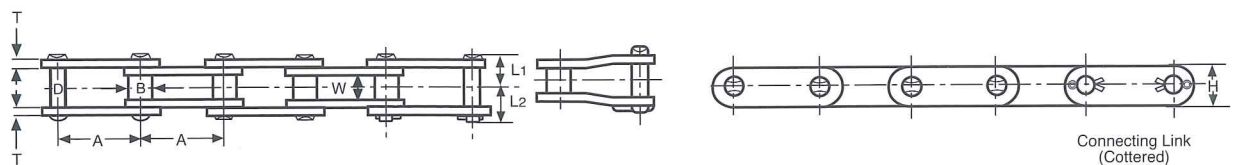

HKK Nickel Plated Chain No.	Pitch A	Roller		Pin Dia. D	Plate		Overall Width		Average Ultimate Strength (lbs)	Avg. Weight Per Foot (lbs) Riveted
		Dia. B	Width W		Height H	Thickness T	L1	L2		
HKK C 2040-NP	1	0.312	5/16	0.156	0.450	0.060	0.323	0.378	4,300	0.32
HKK C 2050-NP	1-1/4	0.400	3/8	0.200	0.591	0.080	0.400	0.467	7,200	0.55
HKK C 2060H-NP	1-1/2	0.469	1/2	0.234	0.670	0.125	0.565	0.657	12,300	0.93
HKK C 2080H-NP	2	0.625	5/8	0.312	0.890	0.156	0.699	0.829	20,200	1.56

Transmission type also available.

Dimensions in inches & pounds

Side Bow Chain

**QUICK
REFERENCE
GUIDE**

- Solid Roller ➤ Solid Bushing ➤ Operates On Standard Sprockets
- Cotter Connecting Links

HKK Side Bow roller chain consists of standard solid roller / solid bushing roller links. Specially designed pin links allow increased clearance between pins and bushings and between the roller link and pin link plates. This feature gives the chain freedom to slightly twist or curve on a horizontal plane.

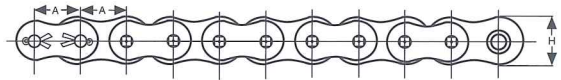
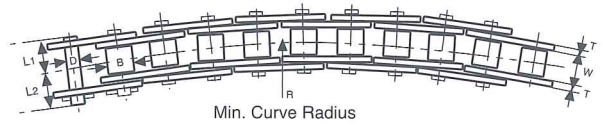

HKK Side Bow Chain No.	Pitch A	Roller		Pin	Plate		Overall Width		Min. Curve Radius	Maximum Allowable Load (lbs)	Average Ultimate Strength (lbs)	Avg. Weight Per Foot (lbs) Riveted
		Dia. B	Width W	Dia. D	Height H	Thickness T	L1	L2				
HKK 40-SB	1/2	0.312	.312	0.141	0.457	0.060	0.335	0.401	13.780	400	3,510	0.41
HKK 50-SB	5/8	0.400	.375	0.175	0.571	0.080	0.407	0.483	15.748	700	5,460	0.68
HKK 60-SB	3/4	0.469	0.500	0.200	0.689	0.094	0.512	0.583	19.685	950	7,300	0.94
HKK 80-SB	1	0.625	0.625	0.281	0.921	0.125	0.654	0.736	23.622	1,700	14,000	1.66

Dimensions in inches & pounds

Hollow Pin Chain

**QUICK
REFERENCE
GUIDE**

- Solid Hollow Pin Bushing ➤ Perfectly Cylindrical Inside Bushing Diameter ➤ Operates On Standard Sprockets

HKK Hollow Pin chains are constructed with cold-forged solid bushings. This process assures the inside diameter of the bushing is completely cylindrical all the way through. This unique hollow pin feature allows easy insertion of cross rods without damaging the chain or rods. Hollow Pin chain operates on standard sprockets and standard double pitch sprockets.

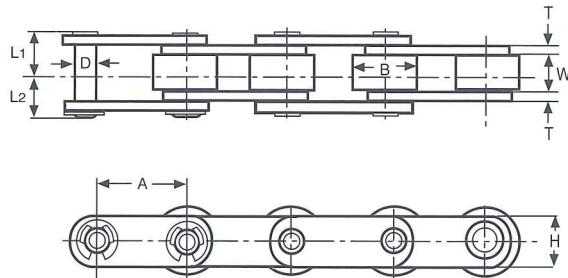
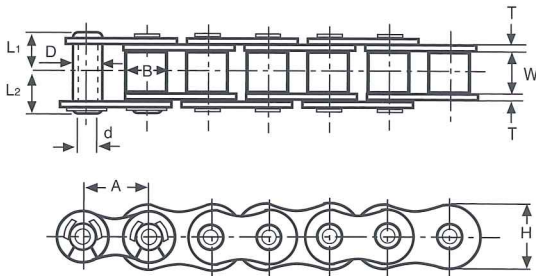

HKK Hollow Pin Chain No.	Pitch A	Roller		Pin		Plate		Overall Width		Maximum Allowable Load (lbs)	Average Ultimate Strength (lbs)	Avg. Weight Per Foot (lbs)
		Dia. B	Width W	Outside Dia. D	Inside Dia. d	Height H	Thickness T	L1	L2			
HKK 40-HP	1/2	0.312	0.312	0.222	0.158	0.472	0.060	0.327	0.362	400	3,000	0.39
HKK 50-HP	5/8	0.400	0.375	0.280	0.202	0.591	0.080	0.404	0.453	700	4,400	0.65
HKK 60-HP	3/4	0.469	0.500	0.327	0.238	0.718	0.094	0.508	0.555	950	7,500	0.98
HKK 80-HP	1	0.625	0.625	0.446	0.318	0.949	0.125	0.638	0.758	1,700	11,400	1.66
Conveyor Type												
HKK C2040-HP	1	0.312	0.312	0.222	0.158	0.472	0.060	0.327	0.362	400	3,000	0.31
HKK C2050-HP	1-1/4	0.400	0.375	0.280	0.202	0.591	0.080	0.404	0.453	700	4,400	0.51
HKK C2060-HP	1-1/2	0.469	0.500	0.327	0.238	0.670	0.094	0.508	0.555	950	7,500	0.75
HKK C2080-HP	2	0.625	0.625	0.446	0.318	0.890	0.125	0.638	0.758	1,700	11,400	1.33
Carrier Roller Type												
HKK C2042-HP	1	0.625	0.312	0.222	0.158	0.472	0.060	0.327	0.362	400	3,000	0.54
HKK C2052-HP	1-1/4	0.750	0.375	0.280	0.202	0.591	0.080	0.404	0.453	700	4,400	0.84
HKK C2062-HP	1-1/2	0.875	0.500	0.327	0.238	0.670	0.094	0.508	0.555	950	7,500	1.20
HKK C2082-HP	2	1.125	0.625	0.446	0.318	0.890	0.125	0.638	0.758	1,700	11,400	2.13

Dimensions in inches & pounds

HKK Leaf chains are built of interlaced plates held together by rivet pins. They are built with the same high degree of precision as our roller chains. HKK Leaf chains are used for applications that require strong flexible linkage for transmitting motion or lift. Specially selected steel and unique heat treatment assures high strength and durability. The first number or numbers in leaf chain identifies the chain pitch, the last two numbers identify the chain's lacing. New applications should use BL series leaf chains.

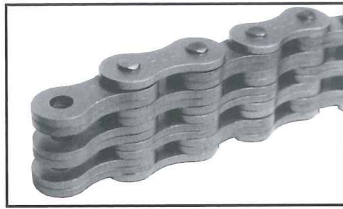

AL SERIES LEAF CHAIN

HKK AL series Leaf chains are constructed of an equal number of plates on both the inner and outer links. AL series chain use the same pin diameter and plate thickness as standard ANSI chains. AL series Leaf chain was removed from ANSI standards in 1975.

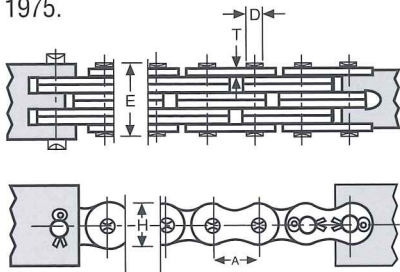

HKK Leaf Chain No.	Assembly	Pitch A	Plate		Pin Dia. D	Overall Width E	Maximum Allowable Load	Average Ultimate Strength (lbs)	Average Weight Per Foot (lbs)
			Height H	Thickness T					
			AL-422	2X2					
AL-444	4X4	1/2	0.404	0.060	0.156	0.33	420	4,000	0.24
AL-466	6X6					0.58	770	8,000	0.46
AL-522	2X2					0.83	880	12,100	0.69
AL-544	4X4	5/8	0.500	0.080	0.200	0.43	680	6,700	0.38
AL-566	6X6					0.76	1180	13,300	0.77
AL-622	2X2					1.10	1400	19,900	1.15
AL-644	4X4	3/4	0.600	0.094	0.234	0.50	990	9,100	0.52
AL-666	6X6					0.89	1670	18,100	1.15
AL-822	2X2					1.28	1950	27,200	1.66
AL-844	4X4	1	0.800	0.125	0.312	0.67	1650	16,100	0.94
AL-866	6X6					1.16	2970	32,200	1.98
AL-1022	2X2					1.69	3450	48,400	3.02
AL-1044	4X4	1-1/4	1.000	0.156	0.375	0.80	2600	23,200	1.68
AL-1066	6X6					1.45	4600	46,300	3.24
AL-1222	2X2					2.11	5390	69,500	4.92
AL-1244	4X4	1-1/2	1.193	0.187	0.437	0.95	3700	32,200	2.35
AL-1266	6X6					1.71	6530	64,500	4.58
AL-1422	2X2					2.50	7670	96,700	6.81
AL-1444	4X4	1-3/4	1.390	0.218	0.500	1.12	5000	41,200	3.25
AL-1466	6X6					2.03	8700	82,600	6.59
AL-1622	2X2					2.93	10,300	124,000	9.83
AL-1644	4X4	2	1.587	0.250	0.562	1.27	6400	52,200	4.05
AL-1666	6X6					2.29	11,200	104,700	8.24
						3.33	13,200	156,900	12.31

Dimensions in inches & pounds

BL SERIES LEAF CHAIN

HKK BL series Leaf chains should be used in all new applications. Greater load capacities are achieved using larger diameter pins and thicker plates. Pin diameters and plate thicknesses are of the next larger size ANSI standard roller chains.

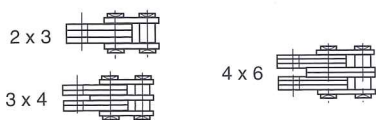
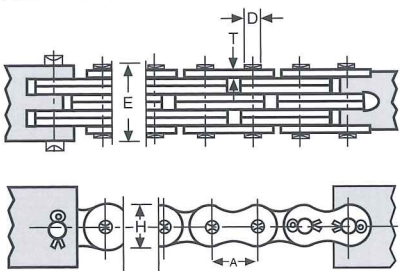

HKK Leaf Chain No.	Assembly	Pitch A	Plate		Pin Dia. D	Overall Width E	Maximum Allowable Load	Average Ultimate Strength (lbs)	Average Weight Per Foot (lbs)
			Height H	Thickness T					
			BL-423	2X3					
BL-434	3X4	1/2	0.457	0.080	0.200	0.51	1000	6,100	0.48
BL-446	4X6					0.68	1190	9,300	0.64
BL-523	2X3					0.93	1340	12,300	0.93
BL-534	3X4	5/8	0.571	0.094	0.234	0.60	1540	9,100	0.74
BL-546	4X6					0.80	1870	13,700	1.03
BL-623	2X3					1.08	2100	18,100	1.46
BL-634	3X4	3/4	0.708	0.125	0.312	0.78	2200	13,700	1.21
BL-646	4X6					1.04	2750	20,600	1.68
BL-823	2X3					1.43	3080	27,400	2.38
BL-834	3X4	1	0.948	0.156	0.375	0.96	3800	23,200	2.05
BL-846	4X6					1.28	4600	35,100	2.85
BL-1023	2X3					1.77	5280	46,300	4.06
BL-1034	3X4	1-1/4	1.154	0.187	0.437	1.13	5830	32,200	2.95
BL-1046	4X6					1.52	7000	50,400	4.08
BL-1223	2X3					2.11	8140	64,500	5.79
BL-1234	3X4	1-1/2	1.382	0.220	0.500	1.33	8250	41,300	4.15
BL-1246	4X6					1.80	9900	67,000	5.85
BL-1423	2X3					2.47	11,300	82,600	8.30
BL-1434	3X4	1-3/4	1.610	0.250	0.562	1.52	11,000	52,400	5.57
BL-1446	4X6					2.05	13,200	86,200	7.75
BL-1623	2X3					2.82	15,100	104,800	11.03
BL-1634	3X4	2	1.839	0.281	0.687	1.72	13,200	78,100	7.51
BL-1646	4X6					2.33	15,800	118,300	10.45
						3.21	18,000	156,300	14.85

Dimensions in inches & pounds

**QUICK
REFERENCE
GUIDE**

- ▶ Break Chain Without The Use Of Hammers
- ▶ Assemble Connecting Links Fast
- ▶ Replaceable Breaking Tips
- ▶ Available For Most Chain

HKK chain breakers and chain pullers make disassembling and connecting chains fast and easy. Chain breakers (available in three sizes) remove pins from chain without the use of hammers or punches. Breaking tip are replaceable. Chain pullers (also available in three sizes) make assembling connecting links onto the chain fast and easy.

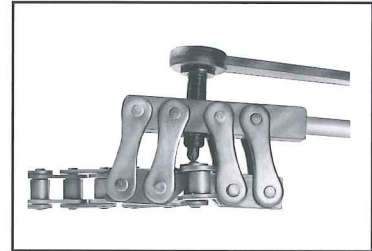
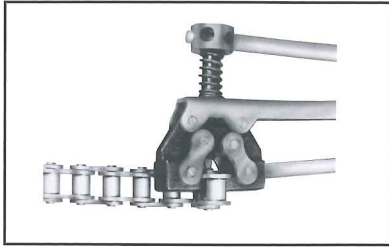

Size	HKK Number	Chain Sizes
Chain Breakers		
#1 Chain Breaker	CB01	25 - 60
#2 Chain Breaker	CB02	60 - 100
#3 Chain Breaker	CB03	120 - 160
Chain Pullers		
#35 Chain Puller	CT35PUL	35 - 60
#60 Chain Puller	CT60PUL	60 - 100
#80 Chain Puller	CT80PUL	80 - 200

**QUICK
REFERENCE
GUIDE**

- ▶ Made From Solid Roller, Solid Bushing Chain
- ▶ Available With Connecting Link Or Single Pin Connector
- ▶ Custom Sizes Available

HKK coupling chains are made from our high quality solid roller, solid bushing chains. Manufactured to our own tough standards, they supply the strength and cost efficiency needed for most coupling applications. Standard coupling chains are assembled using a standard connecting link. Single pin connectors are also available. Most common sizes are in stock; many large size coupling chains can be made to order. First numbers designates chain size; second set of numbers designates length.

Size	Pitch	Length	Weight
HKK 35-20	3/8	7.5	0.3
HKK 35-22		8.25	0.3
HKK 40-12	1/2	6.0	0.4
HKK 40-16		8.0	0.5
HKK 40-18		9.0	0.6
HKK 40-20		10.0	0.7
HKK 40-22		11.0	0.8
HKK 50-16	5/8	10.0	1.1
HKK 50-18		11.25	1.3
HKK 60-16	3/4	12.0	2.0
HKK 60-18		13.5	2.2
HKK 60-20		15.0	2.5

Dimensions in Inches & Pounds



**QUICK
REFERENCE
GUIDE**

- Solid Roller ➤ Solid Bushing ➤ Custom Spacing ➤ Stainless Steel
- Nickel Plated ➤ British Standard ➤ Aqua-Series

HKK attachment chains are standard ANSI single and double pitch chains with modified side plates or pins. Attachments may be used for a variety of purposes such as conveying, timing, or alignment. Several types of standard attachments are available from stock while custom attachments can be made to order. HKK carbon steel attachment chains are standard with solid rollers and solid bushings, greatly extending chain life. For corrosive or extreme environments, stainless steel, nickel plated, and Aqua-Series chains are also available. HKK stocks many unique attachments for specialized applications such as the poultry, packaging, and forestry industries.

ATTACHMENT SPACING

When referencing attachment chains, the attachment spacing must be specified. The attachment spacing or centers (space from the center of one attachment to the next) should be referred to in terms of pitches (links). When counting pitches both the outside (pin link) and the inside (roller link) must be counted. Example: Attachments on Every Link (all inside and outside links). Attachments on every second pitch on the pin link (every outside link). Attachments on every second pitch on the roller link (every inside link). Attachment every third pitch (alternating between inside and outside links).

EVERY PITCH

Attachment on both inside and outside links.

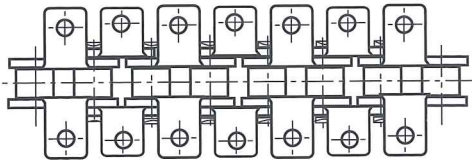

EVERY 3rd PITCH

Attachment alternating on inside and outside.

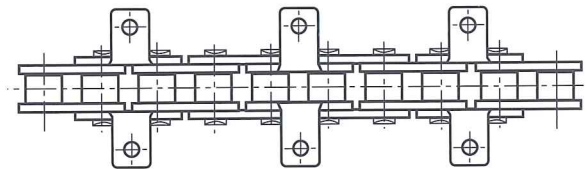

EVERY 2nd Pitch on PIN LINK

Attachment on every outside link.

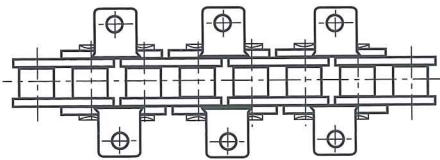

EVERY 4th Pitch on PIN LINK

Attachment on every other outside link.

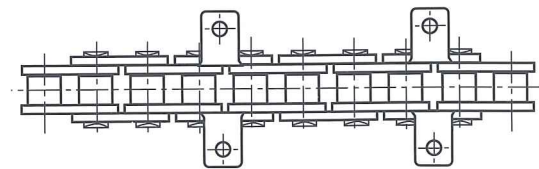

EVERY 2nd Pitch on ROLLER LINK

Attachment on every inside link.

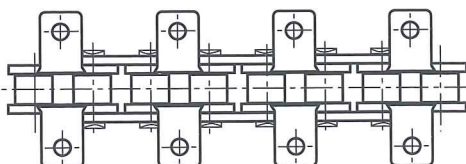

EVERY 4th Pitch on ROLLER LINK

Attachment on every other inside link.

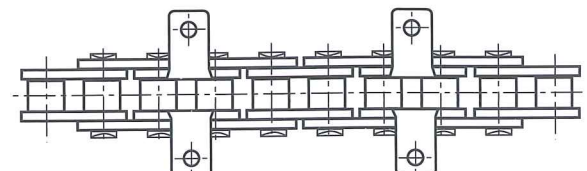

Standard Attachments

HKK Chain stocks most standard attachment chains in carbon steel and stainless steel. Most custom attachment spacing can be assembled with short delivery times. Single pitch chain with two attachment holes in one attachment is considered wide contour. Many custom attachments are also available or can be made to order, (see page 23.)

HKK (new)	HKK (old)	Dodge, Diamond, Morse	Rex, Link Belt
A-1	A-1	B-1, 1 hole	A-1
K-1	K-1	B-2, 1 hole	K-1
A-2	A-2	B-1, 2 hole	A-2
K-2	K-2	B-2, 2 hole	K-2
SA-1	M-1	S-1, 1 hole	M-35
SK-1	MM-1	S-2, 1 hole	M-1
SA-2	M-2	S-1, 2 hole	M-35-2
SK-2	MM-2	S-2, 2 hole	M-2
D-1	D-1	D-1	D-1
D-3	D-3	D-3	D-3

Single Pitch

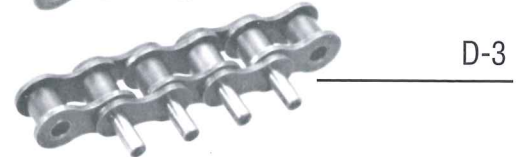
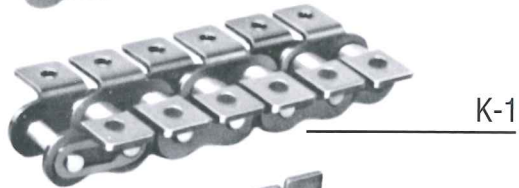

Double Pitch

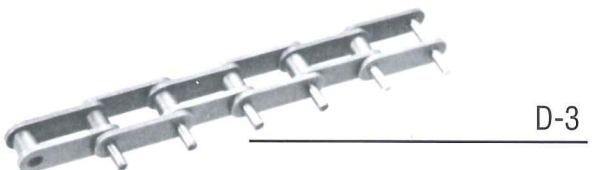
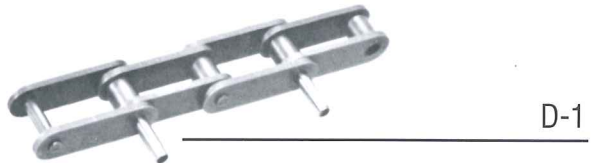
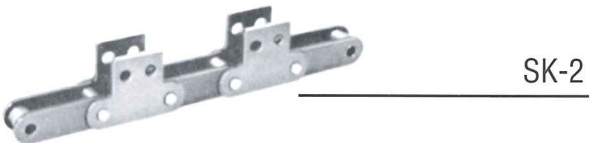
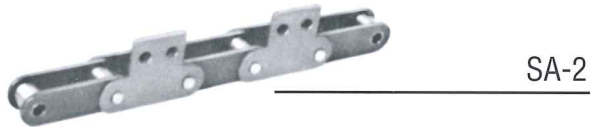

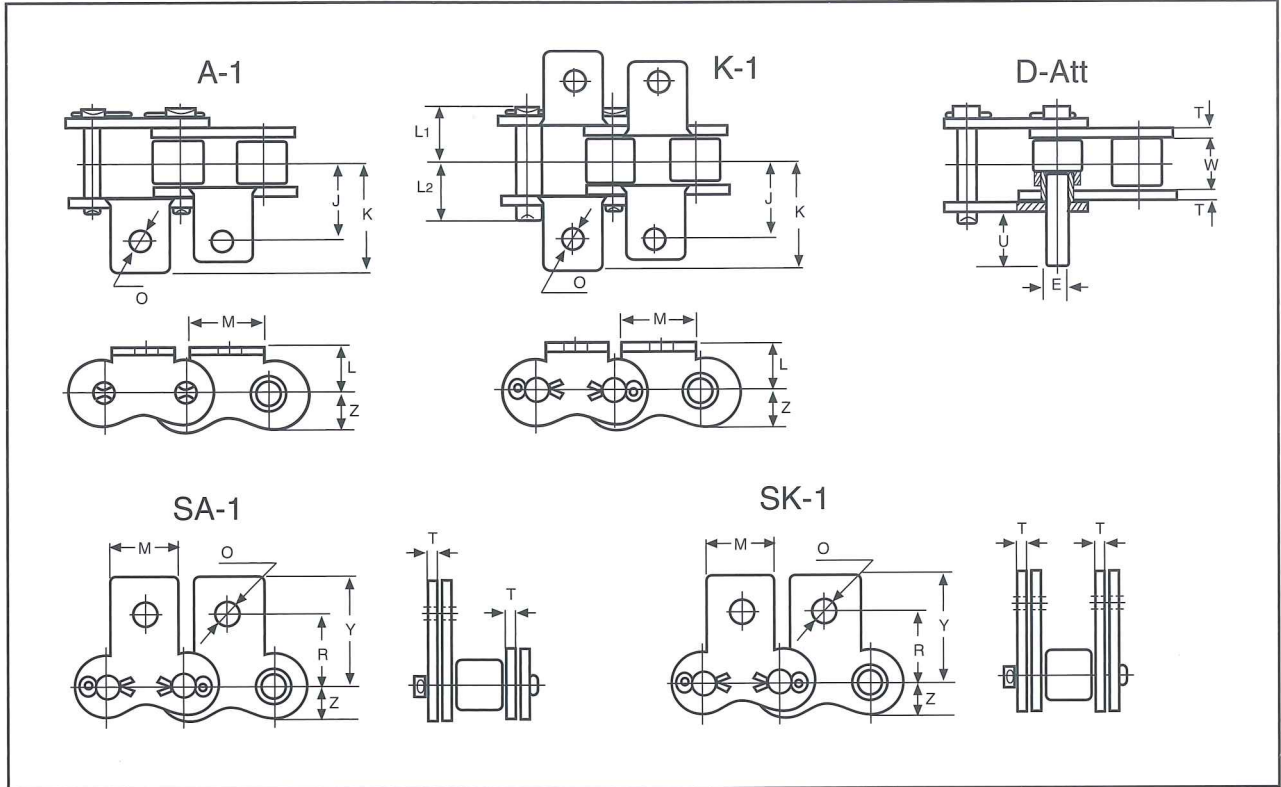

HKK Chain No.	Chain Pitch	J	K	L	M	O	Z	R	Y	E	U
HKK 35	3/8	0.375	0.562	0.250	0.312	0.134	0.174	0.375	0.578	0.141	0.375
HKK 40	1/2	0.500	0.679	0.312	0.375	0.142	0.279	0.500	0.734	0.156	0.375
HKK 50	5/8	0.625	0.917	0.406	0.500	0.205	0.286	0.625	0.906	0.200	0.468
HKK 60	3/4	0.750	1.106	0.468	0.625	0.205	0.343	0.720	1.062	0.234	0.562
HKK 80	1	1.000	1.413	0.625	0.750	0.268	0.457	0.968	1.359	0.312	0.750
HKK 100	1-1/4	1.250	1.742	0.781	1.000	0.346	0.571	1.250	1.703	0.375	0.937
HKK 120	1-1/2	1.500	2.154	0.906	1.125	0.413	0.670	1.437	2.031	0.437	1.125
HKK 140	1-3/4	1.750	2.485	1.125	1.375	0.472	0.805	1.750	2.484	0.500	1.312
HKK 160	2	2.000	2.828	1.250	1.500	0.551	0.919	2.000	2.734	0.562	1.500

Dimensions in inches & pounds

HKK Chain No.	Chain Pitch	T	W	H	L1	L2	Average Weight Per Attachment (lbs)				
							A att	K att	SA att	SK att	D att
HKK 35	3/8	0.050	3/16	0.347	0.233	0.267	0.002	0.004	0.002	0.004	0.002
HKK 40	1/2	0.060	5/16	0.457	0.323	0.354	0.003	0.006	0.003	0.006	0.002
HKK 50	5/8	0.080	3/8	0.571	0.400	0.445	0.009	0.018	0.009	0.018	0.004
HKK 60	3/4	0.094	1/2	0.689	0.500	0.548	0.014	0.028	0.014	0.028	0.005
HKK 80	1	0.125	5/8	0.921	0.628	0.750	0.030	0.060	0.030	0.060	0.024
HKK 100	1-1/4	0.156	3/4	1.154	0.772	0.913	0.059	0.118	0.059	0.118	0.030
HKK 120	1-1/2	0.187	1	1.382	0.971	1.124	0.105	0.210	0.105	0.210	0.050
HKK 140	1-3/4	0.219	1	1.610	1.060	1.228	0.144	0.288	0.144	0.288	0.070
HKK 160	2	0.250	1-1/4	1.839	1.262	1.435	0.195	0.390	0.195	0.390	0.100

Dimensions in inches & pounds

Double Pitch Attachments

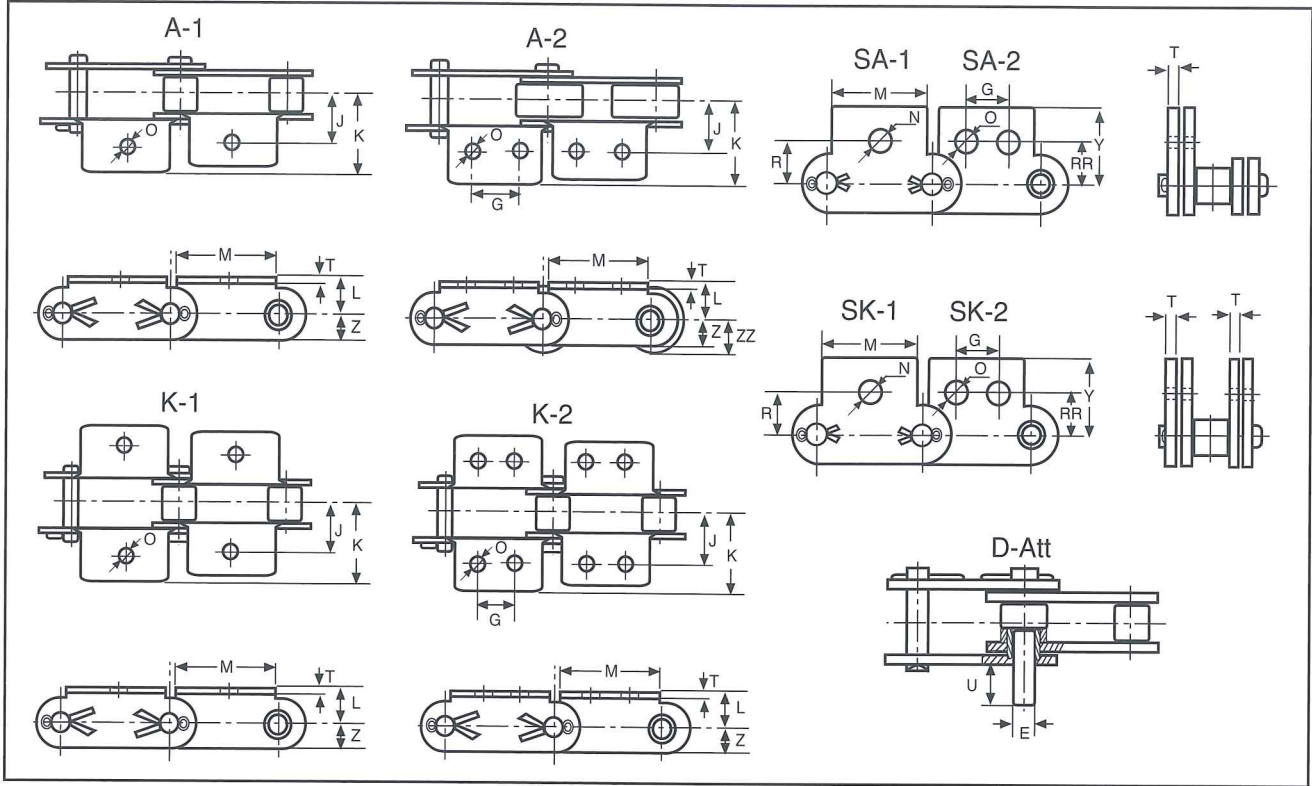

HKK Chain No.	Chain Pitch	J	K	L	M	O	N	G	T	Z	ZZ
HKK C2040 HKK C2042	1	0.500	0.750	0.359	0.750	9/64	13/64	0.375	0.060	0.223	0.312
HKK C2050 HKK C2052	1-1/4	0.625	0.953	0.437	0.937	13/64	17/64	0.468	0.080	0.296	0.375
HKK C2060H HKK C2062H	1-1/2	0.843	1.234	0.578	1.125	13/64	11/32	0.562	0.125	0.335	0.438
HKK C2080H HKK C2082H	2	1.093	1.593	0.750	1.500	17/64	13/32	0.750	0.156	0.445	0.562
HKK C2100H HKK C2102H	2-1/2	1.312	1.968	0.921	1.875	11/32	35/64	0.937	0.187	0.563	0.781
HKK C2120H HKK C2122H	3	1.562	2.437	1.093	2.250	13/32	5/8	1.125	0.218	0.687	0.875
HKK C2160H HKK C2162H	4	2.062	2.984	1.437	3.000	35/64	53/64	1.500	0.281	0.937	1.125

Dimensions in inches & pounds

HKK Chain No.	Chain Pitch	R	RR	Y	E	U	Average Weight Per Attachment (lbs)				
							A att	K att	SA att	SK att	D att
HKK C2040 HKK C2042	1	0.437	0.531	0.781	0.156	0.375	0.007	0.014	0.006	0.012	0.002
HKK C2050 HKK C2052	1-1/4	0.562	0.625	0.968	0.200	0.468	0.014	0.028	0.013	0.026	0.004
HKK C2060H HKK C2062H	1-1/2	0.687	0.750	1.203	0.234	0.562	0.033	0.066	0.032	0.064	0.005
HKK C2080H HKK C2082H	2	0.875	1.000	1.593	0.312	0.750	0.070	0.140	0.070	0.140	0.024
HKK C2100H HKK C2102H	2-1/2	1.125	1.250	1.984	0.375	0.937	0.142	0.284	0.146	0.292	0.030
HKK C2120H HKK C2122H	3	1.312	1.468	2.156	0.437	1.125	0.226	0.452	0.216	0.432	0.050
HKK C2160H HKK C2162H	4	1.750	2.000	3.000	0.562	1.500	0.583	1.166	0.517	1.034	0.100

Dimensions in inches & pounds

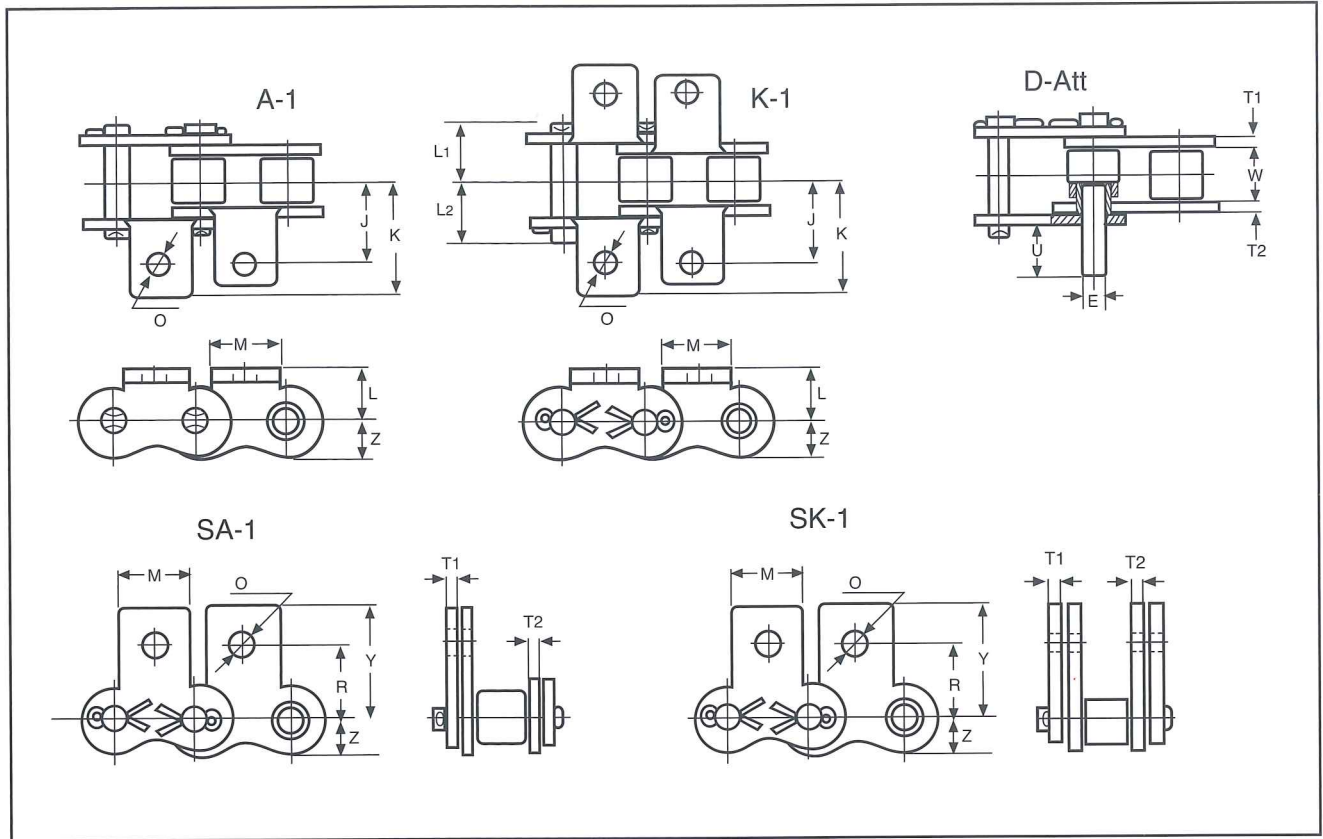

HKK Chain No.	Chain Pitch	J	K	L	M	O	Z	R	Y	E	U
HKK 08B	1/2	0.543	0.823	0.335	0.433	0.169	0.229	0.539	0.819	-	-
HKK 10B	5/8	0.622	0.953	0.413	0.551	0.209	0.289	0.650	0.980	-	-
HKK 12B	3/4	0.693	1.075	0.480	0.709	0.252	0.313	0.728	1.106	-	-
HKK 16B	1	1.142	1.650	0.669	0.945	0.331	0.396	1.079	1.575	-	-
HKK 20B	1-1/4	1.036	1.941	0.827	1.181	0.413	0.512	1.230	1.870	-	-

Dimensions in inches & pounds

HKK Chain No.	Chain Pitch	T1	T2	W	L1	L2	Average Weight Per Attachment (lbs)				
							A att	K att	SA att	SK att	D att
HKK 08B	1/2	0.060	0.060	0.305	0.329	0.363	0.003	0.006	0.003	0.006	0.002
HKK 10B	5/8	0.065	0.065	0.380	0.374	0.422	0.009	0.018	0.009	0.018	0.004
HKK 12B	3/4	0.070	0.070	0.460	0.414	0.491	0.014	0.028	0.014	0.028	0.005
HKK 16B	1	0.122	0.154	0.670	0.691	0.805	0.030	0.060	0.030	0.060	0.024
HKK 20B	1-1/4	0.138	0.178	0.770	0.791	0.922	0.059	0.118	0.059	0.118	0.030

Dimensions in inches & pounds

HKK offers many other non-standard attachments. HKK also stocks many specialized attachments for many particular industries, such as poultry, packaging lumber and many others. HKK can design and manufacture attachments tailored to any application or industry.



**QUICK
REFERENCE
GUIDE**

- Precise Automated Welding ➤ Specially Selected Alloy Steel
- State Of The Art Heat Treatment

HKK welded steel mill chain is manufactured to the same high quality standards as our ANSI chain. Specially selected steel, automated welding process, and computer-controlled heat-treatment provide the strength and durability for even the toughest applications. WR, WRC, and WD have heat treated pins only. WH, WHC, and WDH have all parts heat-treated.

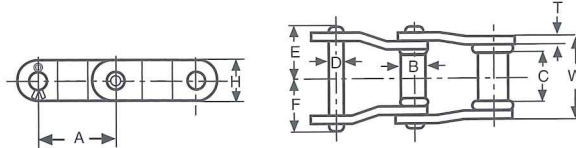

HKK Chain No.	Pitch A	Avg. Ultimate Strength	Allowable Working Load	Barrel Dia. B	Barrel Face C	Pin Dia. D	Width Rivet E	Width Cotter F	Sidebar Height H	Sidebar Thickness T	Bearing Length W	Avg. Weight per foot
WR 78	2.609	24,000	3,000	7/8	1-1/8	1/2	1-15/32	1-5/8	1-1/8	1/4	2	4.0
WH 78	"	36,000	3,500	"	"	"	"	"	"	"	"	"
WR 82	3.075	26,000	3,800	1-1/16	1-17/64	9/16	1-5/8	1-25/32	1-1/4	1/4	2-1/4	5.5
WH 82	"	40,000	4,500	"	"	"	"	"	"	"	"	"
WR 124	4.000	46,000	6,300	1-7/16	1-5/8	3/4	2-3/32	2-21/64	1-1/2	3/8	2-3/4	8.5
WH 124	"	60,000	7,350	"	"	"	"	"	"	"	"	"
WR 111	4.760	46,000	7,550	1-7/16	2-1/4	3/4	2-25/64	2-19/32	1-1/2	3/8	3-3/8	8.4
WH 111	"	60,000	8,850	"	"	"	"	"	"	"	"	"
WR 106	6.000	46,000	6,750	1-1/4	1-5/8	3/4	2-3/64	2-21/64	1-1/2	3/8	2-13/16	7.0
WH 106	"	60,000	7,850	"	"	"	"	"	"	"	"	"
WR 132	6.050	84,000	13,100	1-5/8	3	1	3-5/32	3-17/32	2	1/2	4-3/8	13.4
WH 132	"	100,000	15,000	"	"	"	"	"	"	"	"	"

Dimensions in inches & pounds

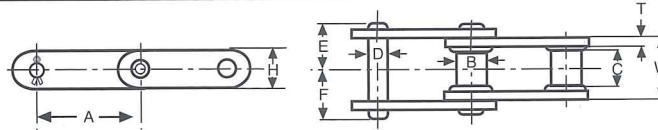

HKK Chain No.	Pitch A	Avg. Ultimate Strength	Allowable Working Load	Barrel Dia. B	Barrel Face C	Pin Dia. D	Width Rivet E	Width Cotter F	Sidebar Height H	Sidebar Thickness T	Bearing Length W	Avg. Weight per foot
WRC 188	2.609	24,000	3,000	7/8	15/16	1/2	1-15/32	1-21/32	1-1/8	1/4	1-7/8	3.7
WHC 188	"	36,000	3,500	"	"	"	"	"	"	"	"	"
WRC 78	2.609	24,000	3,000	7/8	1-1/8	1/2	1-15/32	1-5/8	1-1/8	1/4	2	4.0
WHC 78	"	36,000	3,500	"	"	"	"	"	"	"	"	"
WRC 82	3.075	26,000	3,800	1-1/16	1-17/64	9/16	1-5/8	1-25/32	1-1/4	1/4	2-1/4	5.5
WHC 82	"	40,000	4,500	"	"	"	"	"	"	"	"	"
WRC 131	3.075	46,000	5,000	1-1/8	1-1/4	5/8	1-25/32	2-3/32	1-1/2	3/8	2-3/8	6.8
WHC 131	"	60,000	5,700	"	"	"	"	"	"	"	"	"
WRC 124	4.000	46,000	6,300	1-7/16	1-5/8	3/4	2-3/32	2-21/64	1-1/2	3/8	2-3/4	8.5
WHC 124	"	60,000	7,350	"	"	"	"	"	"	"	"	"
WRC 111	4.760	46,000	7,550	1-7/16	2-1/4	3/4	2-25/64	2-19/32	1-1/2	3/8	3-3/8	8.4
WHC 111	"	60,000	8,850	"	"	"	"	"	"	"	"	"
WRC 106	6.000	46,000	6,750	1-1/4	1-5/8	3/4	2-3/32	2-21/64	1-1/2	3/8	2-3/4	7.0
WHC 106	"	60,000	7,850	"	"	"	"	"	"	"	"	"
WRC 132	6.050	84,000	13,100	1-5/8	3	1	3-5/32	3-17/32	2	1/2	4-3/8	13.4
WHC 132	"	100,000	15,000	"	"	"	"	"	"	"	"	"

Dimensions in inches & pounds

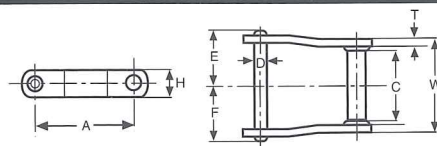

HKK Chain No.	Pitch A	Avg. Ultimate Strength	Allowable Working Load	Barrel Dia. B	Barrel Face C	Pin Dia. D	Width Rivet E	Width Cotter F	Sidebar Height H	Sidebar Thickness T	Bearing Length W	Avg. Weight per foot
WD 102	5.000	51,000	8,500	"	6-1/2	3/4	4-9/16	4-27/32	1-1/2	3/8	7-5/8	12.0
WD 104	6.000	51,000	8,500	"	4-1/8	3/4	3-1/2	3-25/32	1-1/2	3/8	5-1/2	8.6
WD 110	"	51,000	8,500	"	9	"	5-29/32	6-3/32	"	"	10-3/8	12.5
WD 120	"	80,000	12,300	"	8-3/4	7/8	6-1/8	6-9/16	2	1/2	10-1/2	22.0
WD 112	8.000	51,000	8,500	"	9	3/4	5-29/32	6-3/32	1-1/2	3/8	10-3/8	11.2
WD 116	"	"	"	"	13	"	7-43/64	7-61/64	1-3/4	"	14-1/8	16.0
WD 118	"	80,000	12,300	"	13-1/4	7/8	8-3/8	8-13/16	2	1/2	14-7/8	26.0
WD 122	"	"	"	"	8-3/4	"	6-1/8	6-9/16	"	"	10-1/2	17.5
WD 480	"	"	"	"	11-1/32	"	7-17/64	7-45/64	"	"	12-13/16	19.8

Dimensions in inches & pounds

**QUICK
REFERENCE
GUIDE**

- Solid Roller ➤ Solid Bushing ➤ Shot-Peened Surfaces ➤ Specially Selected Alloy Steel ➤ State Of The Art Heat Treatment Process

HKK provides three types of 81X series engineering class conveyor chains: 81X, 81XH Heavy, and 81XH-S Heavy Special. Each type is designed with different link plate thickness and height to achieve progressively higher allowable loads and durability. HKK's 81X series chains are all equipped with cold-forged, shot peened, solid rollers and solid bushings. This, accompanied with specially selected alloy steels and a computer monitored heat treatment process, ensures long life under the harshest conditions.

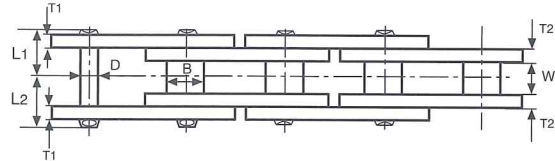
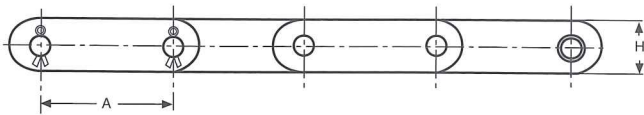

HKK Chain 81X No.	Pitch A	Roller		Pin Dia. D	Plate		Overall Width		Max. Allowable Load (lbs)	Avg. Ultimate Strength (lbs)	Avg. Weight Per Foot (lbs.)	
		Dia. B	Width W		Height H	Thickness	L1	L2				
HKK81X	2.609	0.906	1.062	0.437	1.125	0.156	0.156	0.945	1.118	2,700	25,000	2.6
HKK81XH	2.609	0.906	1.062	0.437	1.264	0.218	0.312	1.188	1.343	6,830	42,000	3.9
HKK81XH-S	2.609	0.906	1.062	0.437	1.264	0.312	0.312	1.260	1.430	6,830	42,000	4.6

Warning: Welding on any heat-treated chain will distort the heat treatment and severely deteriorate chain quality.

Dimensions in inches & pounds

81X Attachments

**QUICK
REFERENCE
GUIDE**

- Solid Roller ➤ Solid Bushing ➤ Custom Spacing
- State Of The Art Heat Treatment Process

HKK 81X attachments are manufactured using specially selected alloy steel, and a state of the art heat treatment process. Roller link attachments have cold-forged solid bushings and solid rollers. Custom spacing of attachments are readily available.

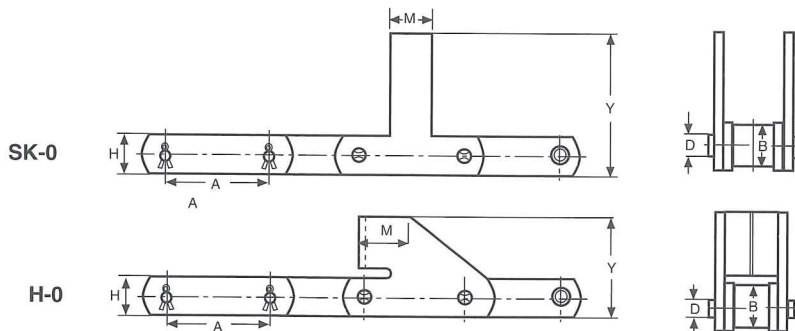

HKK 81X Att.	Pitch A	Roller Dia. B	Pin Dia. D	Plate Height H	Attachment		Max Allowable Load (lbs)	Avg. Ultimate Strength (lbs)	Avg. Weight per Att.
					Height Y	Width M			
H-0	2.609	0.906	0.437	1.125	3.125	1.173	2,700	25,000	1.0
SK-0	2.609	0.906	0.437	1.125	6.250	1.500	2,700	25,000	1.3

Dimensions in inches & pounds

81X Roof-Top Chain

**QUICK
REFERENCE
GUIDE**

- Solid Bushing ➤ Solid Roller ➤ Side Split Roof Top ➤ No Ridges
- Smooth Top

HKK 81X Roof-Top chain has a unique side split feature. This smooth style roof-top will help protect transferring lumber from scratches and dents while reducing build up of unwanted dust in the chain mechanism. Cold forged solid rollers and solid bushings greatly extend chain life. Specially selected alloy steel and a computer monitored heat treatment process ensure high strength and durability.

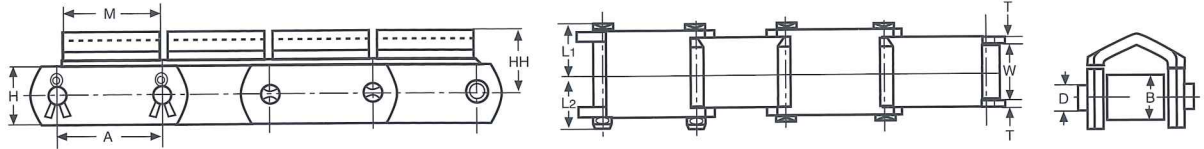

HKK 81X Roof-Top Chain	Pitch A	Roller		Pin Dia. D	Plate		Roof Width M	Overall Dimension		Roof Height HH	Max. Allowable Load (lbs)	Avg. Ultimate Strength (lbs)	Avg. Weight Per Foot (lbs)
		Dia. B	Width W		Height H	Thickness T		L1	L2				
	2.609	0.906	1.063	0.438	1.125	0.156	2.500	0.938	1.125	1.250	2,700	25,000	3.7

Dimensions in inches & pounds

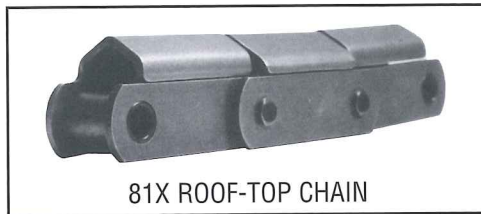

Sticker Chain

**QUICK
REFERENCE
GUIDE**

- Solid Bushing ➤ Solid Roller ➤ Solid Sticker Available
- Faster Processing

HKK Sticker chains have a solid foundation in the lumber industry. Cold forged solid rollers, solid bushings, proven sticker points, and through hardened pins provide high durability and productivity with minimum stretch even at the highest RPMs.

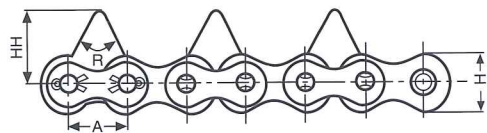
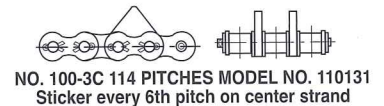
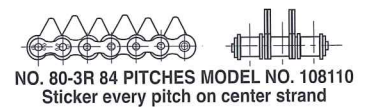
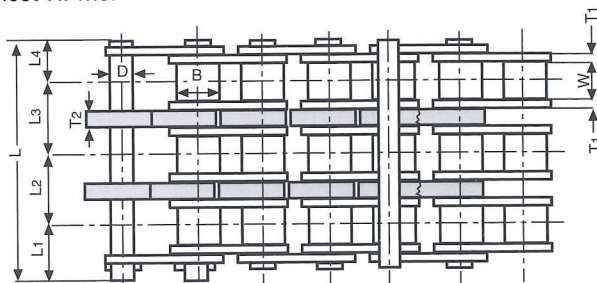

HKK STICKER CHAIN	HKK No.	Pitch A	Roller		Pin Dia. D	Plate		Overall Dimension					Sticker Height HH	Sticker Thickness T2	Sticker Angle R	Avg. Ultimate Strength (lbs)	Avg. Weight Per Foot
			Dia. B	Width W		Height H	Thickness T1	L	L1	L2	L3	L4					
			B	W		H	T1	L	L1	L2	L3	L4					
80-3R	108110	1.000	.625	.625	.312	.914	.125	3.678	.745	1.153	1.153	0.627	1.25	.125	60	53,000	5.54
80-3R	108139	1.000	.625	.625	.312	.914	.125	3.678	.745	1.153	1.153	0.627	1.25	.250	60	53,100	5.54
100-3C	110131	1.250	.750	.750	.375	1.154	.156	4.503	.913	1.409	1.409	0.772	1.535	.312	80	78,600	8.05

Dimensions in inches & pounds

Edger Chain

QUICK REFERENCE GUIDE

- Solid Roller ➤ Solid Bushing ➤ Through Hardened Pins
- Less Wood Damage ➤ Faster Processing

HKK Edger chain is well suited for today's high output lumber industry. Our cold-forged solid rollers, solid bushing, and solid center plates, along with through-hardened pins make HKK chain extremely durable even at high rpms. Shot-peened side plates made from specially selected alloy steel have a proven point tooth design for higher grip with less down force.

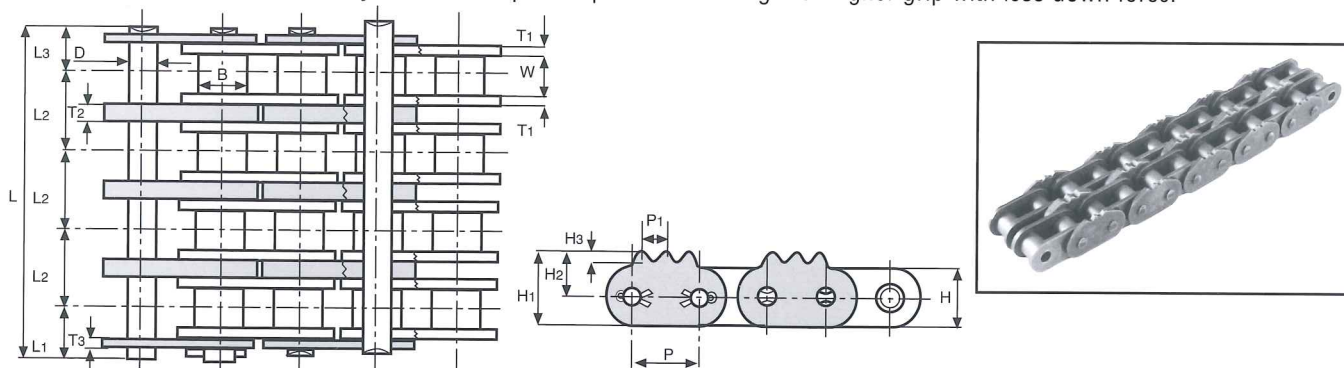

HKK Edger Chain	HKK Part No.	Pitch		Roller		Pin	Plate						Overall Dimension				Avg. Ultimate Strength	Avg. Weight Per Foot		
		P	P1	Dia.	Width		Dia.	Height				Thickness			L	L1			L2	L3
					B	W		D	H	H1	H2	H3	T1	T2						
80*	108203	1.000	.375	.625	.625	.312	.914	1.143	.686	.125	.125	-	.125	1.388	.760	-	.628	17,700	2.1	
80-2	108246	1.000	.375	.625	.625	.312	.914	1.143	.686	.125	.125	.250	.125	2.545	.760	1.153	.628	35,400	4.0	
80-3	108160	1.000	.375	.625	.625	.312	.914	1.143	.686	.125	.125	.250	.125	3.694	.760	1.153	.628	53,100	6.0	
80-4	108205	1.000	.375	.625	.625	.312	.914	1.143	.686	.125	.125	.250	.125	4.847	.760	1.153	.628	70,800	8.0	
100-2	110165	1.250	.375	.750	.750	.375	1.142	1.325	.754	.125	.156	.312	.156	3.095	.914	1.409	.772	52,400	6.0	

Note: Other profile of edger is also available upon request.

* Case Hardened Pins

Dimensions in inches & pounds

Heavy Edger Chain

QUICK REFERENCE GUIDE

- Solid Roller ➤ Solid Bushing ➤ Runs On Standard Sprockets
- Through Hardened Pins ➤ Less Wood Damage ➤ Faster Processing

HKK 80-2 Heavy Edger chain is manufactured to handle higher capacity and shock loads than standard chains. Cold forged solid bushings, solid rollers and thicker outside plates provide longer life with less chain elongation. Shot-peened side plates made from specially selected alloy steel have a proven point tooth design for higher grip with less down force. HKK 80-2 Heavy edger chain runs on standard 80-2 sprockets to provide easy installation.

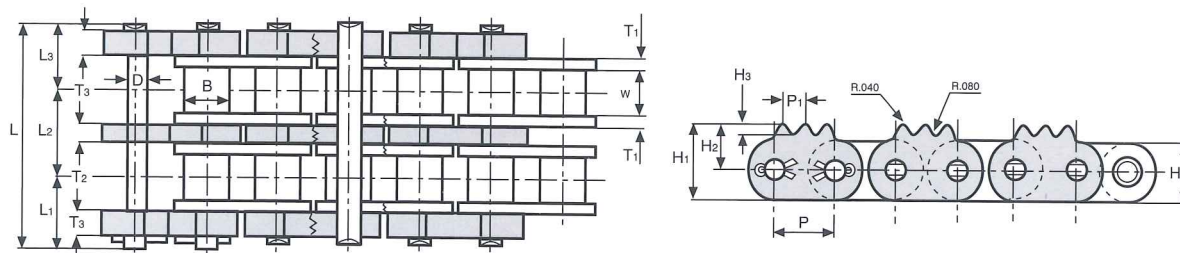

HKK Edger Chain	HKK Part No.	Pitch		Roller		Pin	Plate						Overall Dimension				Avg. Ultimate Strength	Avg. Weight Per Foot		
		P	P1	Dia.	Width		Dia.	Height				Thickness			L	L1			L2	L3
					B	W		D	H	H1	H2	H3	T1	T2						
80-2H	108518A	1.000	.375	.625	.625	.312	.914	1.143	.686	.125	.156	.187	.250	2.851	.910	1.153	.788	40,400	5.0	

Dimensions in inches & pounds

CAUTION: PLEASE READ CAREFULLY

- 1) Guards must be provided on all chain and sprocket installations in accordance with provisions of ANSI/ASME B15.1 Standards for Mechanical Power Transmission Apparatus, and ANSI/ASME B20.1 Safety Standards for Conveyors and Related Equipment, or other applicable safety standards. When revisions of these standards are published, the updated version shall apply.
- 2) Always lock out machinery power switch before attempting removal, installation, or any servicing of chain.
- 3) Wear eye and face protection when grinding, driving or disassembling pins.
- 4) Always wear gloves, protective clothing and safety shoes with steel toe when working with chains.
- 5) Make absolutely sure that chain is properly supported to prevent uncontrolled movement of chain and parts.
- 6) Chain pressers and breaking tools are recommended and should be in good working order and used according to instructions.
- 7) Do not attempt to connect, disconnect, or alter chain unless you are aware of the chain construction, including pin/rivet removal and the correct use of connecting links.
- 8) Chains made by different manufacturers should not be joined together with HKK chain in the same application.
- 9) Avoid plating or welding assembled chains or components.
- 10) Never repair damaged chains by replacing only the component parts.
- 11) Average Ultimate Strength of a chain is breaking load collected through a destruction tensile test. Never apply your working load over the maximum allowable load.

Maintenance Check List

Inspect on a regularly scheduled basis for worn, damaged or broken parts, possible interference by other systems components, and proper lubrication. Normal maintenance procedures can prevent most of the conditions described below. Carefully inspect roller chain drives on the same schedule as associated equipment.

Sprocket Misalignment

Wear on the sides of sprocket teeth generally indicates improper installation of sprockets and/or shafts. If shafts are out of parallel or not in the same plane, non-symmetrical wear will appear on sprockets or chain rollers.

After proper alignment is made retighten set screws in sprocket hubs.

Chain Wear and Elongation

Normal wear will cause some increase in chain length. However, if a sudden increase in elongation occurs, look for severe wear on the tips of sprocket teeth. This may be caused by any of the following: excessive loading or shock loading, displacement and/or wear in bearings, displacement of take-ups, or under-designed drives. Excessive elongation may be an indication that chain and/or sprockets should be replaced.

Before replacing chain or sprockets, recalculate initial drive design. Check chain tension if there is too much accumulated slack in the drive.

Broken Chain Parts

Generally caused by an overloaded drive; extreme misalignment; excessive elongation causing chain to jump sprocket teeth; heavy shock; improper drive design geometry; foreign objects.

Recalculate initial drive design and make necessary corrections. Inspect sprockets and shafts for proper alignment or looseness.

Link Plate Wear

Wear on inside of the link plates and on one side of sprocket teeth may be caused by a misalignment of sprockets.

Realign sprockets and shafts. Inspect chain carefully, readjust chain properly or replace.

Excessive Noise

Can be caused by broken links and chain rollers, extreme misalignment, elongation, chain jumping sprocket teeth, loose sprockets, broken teeth, accumulation of dirt packed into the chain or sprockets teeth, interference by foreign objects, contacting a fixed object.

Check for worn broken or missing parts. Check alignment of shafts and/or sprockets.

Improper Lubrication

Light or dark brown discoloration of pin-bushing joints and connecting link pins, or brown-red oxide color in oil may indicate chain is not dipping into the oil reservoir, or drip lubricator or spray is plugged.

Carefully clean and dry chain, immerse in oil, and re-install. Change oil in chain case and flush case. Determine if oil supply is adequate or unimpeded.

Recommended Replacement

Chain is worn-out and should be replaced when it stretches between .08% and 1.5% of its length. Chain should also be replaced if any component parts are broken or excessively worn.

Removing Chain

Turn the drive until a connecting link is fully engaged with one of the sprockets so as to relieve the tension on the connecting pin. The connecting link may then be removed.

Cutting Riveted Chain

The two pins of a pin link must be driven out of the link plate. Strike the pins alternately to avoid distortion of the roller link plates as well as the plates of the adjacent links. Chain cutting tools can also be used. Follow their instruction carefully.

Inserting New Links

Insert only on new roller chain. Pitch variance between a new link and those on an old chain, especially one which is elongated due to wear, will cause shock when the new link engages the sprocket.

Installing New Chain

Chain and/or related parts should be visually inspected for damage, which could have occurred during shipping prior to installation. Never install new chain on worn sprockets as this will permanently damage chain. With new chain and sprockets installed, check for proper tension and alignment.

Periodic Cleaning

Remove chain from sprockets and clean with brush or rag. If chain is badly gummed, soak in cleaner, rinse, and soak chain in oil to restore lubrication. Clean sprockets; carefully inspect chain and sprockets before reinstalling.

Storing Chain

When roller chain is taken out of operation for prolonged periods, remove the chain from the sprockets and cover with heavy grease. Wrap in heavy grease resistant paper and store where the chain will not be exposed to abnormal moisture, temperature, abrasive or corrosive conditions. Sprockets remaining on shafts should be covered with heavy grease. When the drive is put back in service, remove the grease and thoroughly clean chain and sprockets before re-installing.

Heating and Welding

Do not apply heat to chain by cutting torch unless absolutely necessary. Cutting by torch is indicated, chain should be replaced. Welding should not be attempted.

HKK's new Aqua-Series chains are the perfect choice where corrosion resistance and high strength is needed. Aqua-Series chains are specially treated to provide maximum corrosion resistance while maintaining the strength and durability of our carbon steel chains. Aqua-series corrosion resistance is far superior to nickel or zinc plated chains. Aqua-Series chains are manufactured with our standard cold-forged solid rollers and solid bushings, providing longer life with minimum elongation. HKK Aqua-Series chains are ideally suited for harsh outdoor and seawater environments. Aqua-Series chains are also well suited for wash-down applications, outdoor conveyors, farm equipment, paper mills, mining industries and many other applications*. Aqua-Series chains are standard as a flat grey color, and are available in all sizes, including multiple strand and attachment chains. Aqua-Series chains are supplied fully lubricated, and are not prone to the splitting or peeling problems that occur with nickel plated chains.

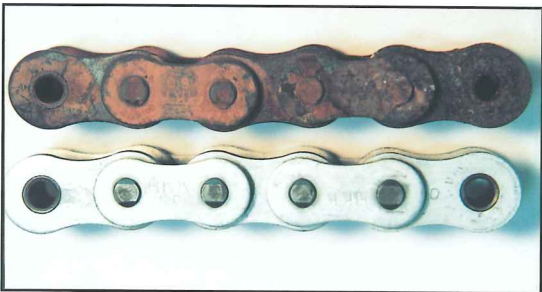

Aqua-Series chain and Carbon Steel chain, tested in water. Testing time 30 days.

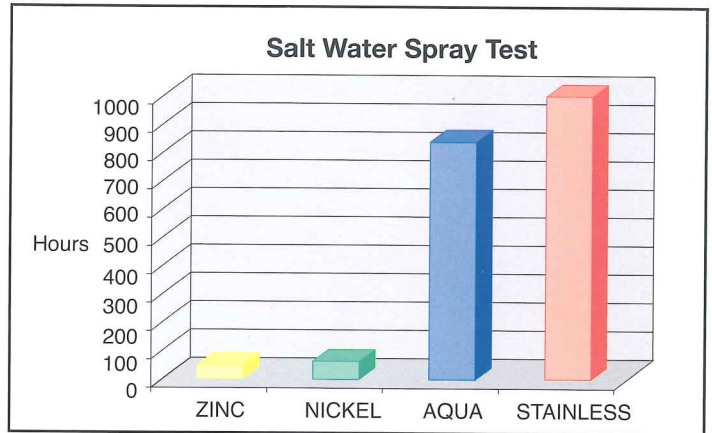

304 Stainless Steel showed no signs of corrosion during our tests.

Salt Water Immersion Test		
Chain Type	Hours to Start Corrosion	Maximum Allowable Load #60
Nickel Plated	48-60	1950 lbs.
Aqua-Series	600-840	1950 lbs.
304 Stainless Steel	840 (No Corrosion)	231 lbs.

304 Stainless Steel showed no signs of corrosion during our tests.

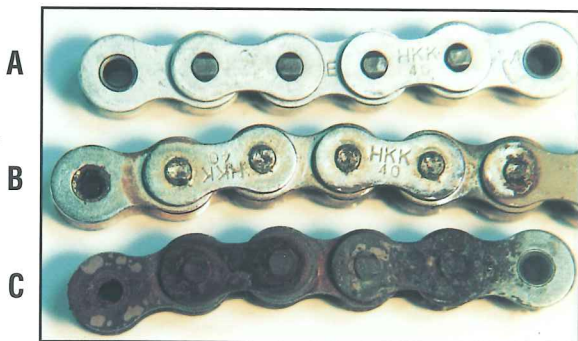

Aqua-Series (A), Nickel Plated (B), and Carbon Steel (C), tested in salt water. Testing time 10 days.

*Aqua-Series chains should not be used in applications where chain may come in contact with food. HKK always recommends using stainless steel when contact with food is possible.

www.hkkchain.com

HKK CHAIN CORPORATION OF AMERICA

9 Riverside Drive • P.O. Box 604 • Pine Brook, NJ 07058-0604

Phone: (973) 575-7860 • Toll Free: 800-631-1056

Fax: (973) 575-7250 • e-mail: sales@hkkchain.com

HKK CHAIN CORPORATION NORTHWEST SALES

9730 S.W. Hillman Court, Suite 630 • Wilsonville, OR 97070

Phone: (503) 682-4933 • Toll Free: 888-242-4933

Fax: (503) 682-1879 • e-mail: nwsales@hkkchain.com

HKK CHAIN CORPORATION MID-WEST SALES

736 Elder Court • Glencoe, IL 60022

Phone: (847) 256-7733 • Fax: (847) 256-7733